

# KINTEK

TURNING TOOLS - PORTAINSERTI



**TURNING TOOLS** 

KLEMMHALTER/BOHRSTANGEN 

ТОКАРНЫЙ ИНСТРУМЕНТ 

PORTE-PLAQUETTES 

PORTAINSERI 

车刀 

KLEMMHALTER FÜR DIE AUSSENBEARBEITUNG  
 ESTERNAL (O.D.) TURNING TOOLS  
 ДЕРЖАВКИ ДЛЯ ВНЕШНЕГО ТОЧЕНИЯ  
 PORTA-PLAQUETTES EXTERIEURES  
 PORTA INSERTI PER ESTERNI  
 外部车刀

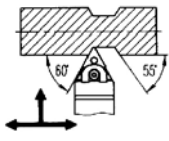

**MTEN**  
Page 573

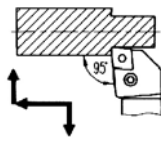

**PCLN**  
Page 575

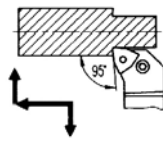

**PWLN**  
Page 578

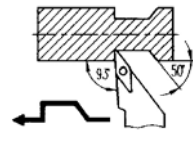

**SVJB**  
Page 580

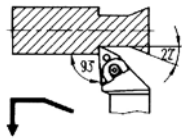

**MTJN**  
Page 573

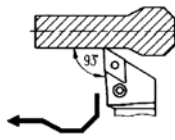

**PDJN**  
Page 576

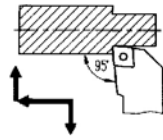

**SCLC**  
Page 578

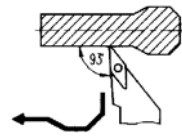

**SVJC**  
Page 581

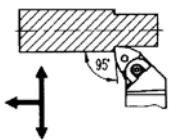

**MWLN**  
Page 574

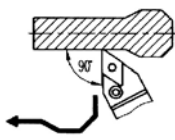

**PDNN**  
Page 576

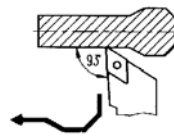

**SDJC**  
Page 579

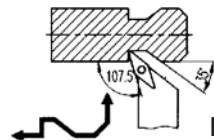

**SVHB**  
Page 581

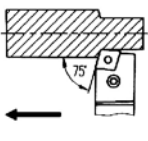

**PCBN**  
Page 574

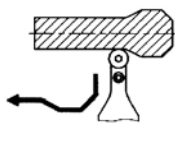

**PRDC**  
Page 577

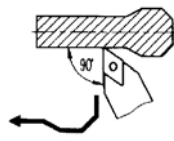

**SDNC**  
Page 579

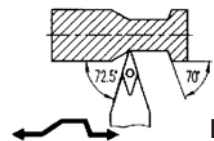

**SVVB**  
Page 582

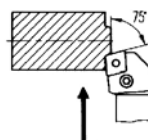

**PCKN**  
Page 575

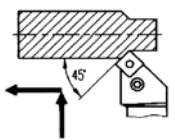

**PSSN**  
Page 577

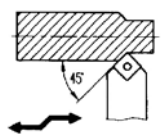

**SSDC**  
Page 580

BOHRSTANG FÜR INNENBEARBEITUNG  
 INTERNAL (I.D.) BORING BARS  
 РАСТОЧНЫЕ ДЕРЖАВКИ  
 BARRES D'ALESAGE  
 BARENI PER INTERNI  
 内部镗头

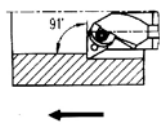

**MTFN**  
Page 584

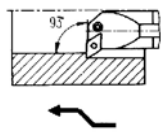

**PCLN**  
Page 585

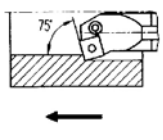

**PSKN**  
Page 586

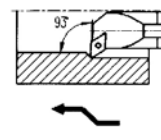

**SDUC**  
Page 587

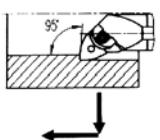

**MWLN**  
Page 584

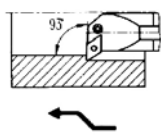

**PDUN**  
Page 585

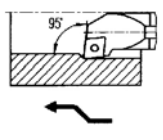

**SCLC**  
Page 586

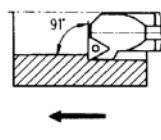

**STFC**  
Page 587



KINTEK TURNING TOOLS

TECHNICAL DATAS

ISO5610 - External turning tools

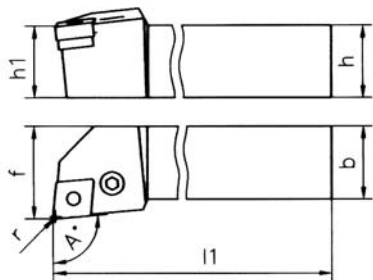

ISO5609 - Internal turning tools

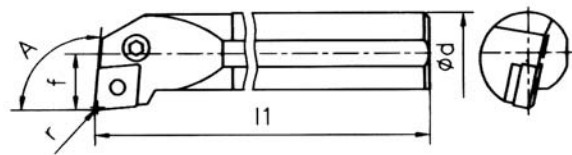

**TOLERANCE**

- h:** h13
- b:** h13
- d:** g7
- f:** +0/+0,5 (External)
- f:** -0/-0,25 (Internal)
- l1:** k16
- h1:** js13

- 1 Turning tools for external and internal machining are produced of hardened steel with an hardness of 43 HRC.
- 2 The head of HM-Boring bars is made of hardened steel.
- 3 The face of turning tools for external is ground.

Inscribed circle of the insert	6,35	7,94	9,525	12,7	15,875	19,05	25,4
Radius r	0,4		0,8		1,2		2,4



KINTEK DREHWERKZEUGE

TECHNISCHE DATEN

ISO5610 - Aussenbearbeitung

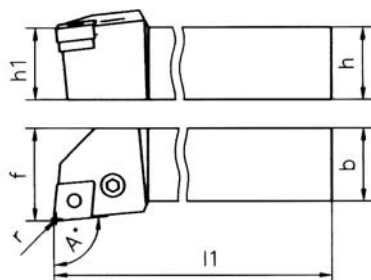

ISO5609 - Innenbearbeitung

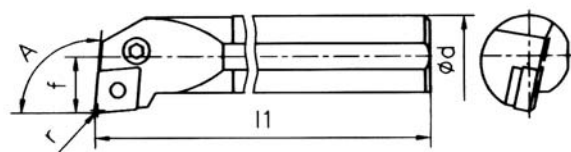

**TOLERANZEN**

- h:** h13
- b:** h13
- d:** g7
- f:** +0/+0,5 (Aussenbearbeitung)
- f:** -0/-0,25 (Innenbearbeitung)
- l1:** k16
- h1:** js13

- 1 Die Klemhalter und Bohrstangen werden aus Vergütungsstahl hergestellt, Harte 43 HRC.
- 2 Der Kopf der HM-Bohrstangen wird auch aus Vergütungsstahl produziert.
- 3 Die Auflagefläche aller Drehwerkzeuge ist geschliffen

Innenkreis der WS-Platte	6,35	7,94	9,525	12,7	15,875	19,05	25,4
Radius r	0,4		0,8		1,2		2,4



### ТОКАРНЫЕ ДЕРЖАВКИ KINTEK

### ТЕХНИЧЕСКИЕ ДАННЫЕ

ISO5610 – Стандарт изготовления наружных державок

ISO5609 – Стандарт изготовления расточных державок

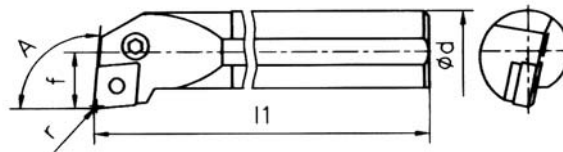
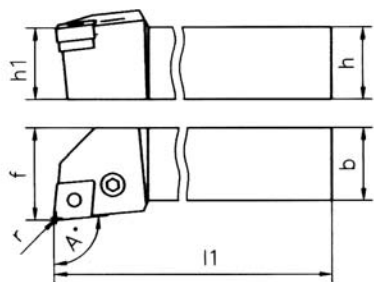

#### ТОЧНОСТЬ

- 1 Материал токарных державок для внешней и внутренней обработки – улучшенная сталь, твердость 43HRC.
- 2 Головки державок с твердосплавным хвостовиком сделаны также из улучшенной стали.
- 3 Торцы державок шлифованы.

**h:** h13  
**b:** h13  
**d:** g7  
**f:** +0/+0,5 (для наружных державок)  
**f:** -0/-0,25 (для расточных державок)  
**l1:** k16  
**h1:** js13

Диаметр вписанной окружности пластины	6,35	7,94	9,525	12,7	15,875	19,05	25,4
Радиус r	0,4		0,8		1,2		2,4



### PORTE OUTILS DE TOURNAGE KINTEK

### DONNEES TECHNIQUES

ISO5610 - A usage externe

ISO5609 - A usage interieur

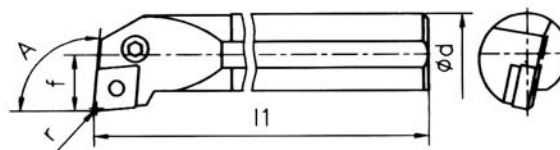
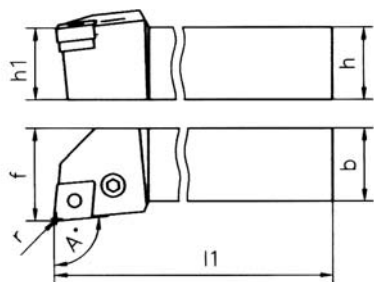

#### TOLERANCE

- 1 Le matériel utilisé pour les outils à usage externe et à usage interieur est: acier bonifié, dureté 43 HRC.
- 2 La tête des outils en carbure est fait en acier bonifié.
- 3 La partie plate des porte outils de tournage à usage externe est rectifié.

**h:** h13  
**b:** h13  
**d:** g7  
**f:** +0/+0,5 (à usage externe)  
**f:** -0/-0,25 (à usage interieur)  
**l1:** k16  
**h1:** js13

Circle inscrit de la plaquette	6,35	7,94	9,525	12,7	15,875	19,05	25,4
Rayon r	0,4		0,8		1,2		2,4



## UTENSILI DI TORNITURA KINTEK

## DATI TECNICI

ISO5610 - Per esterni

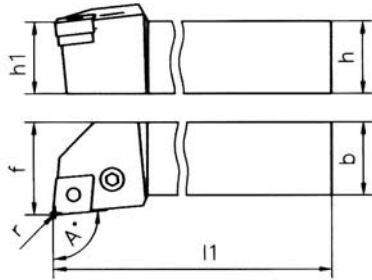

ISO5609 - Per interni

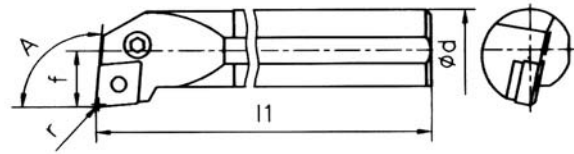

## TOLLERANZE

h: h13  
 b: h13  
 d: g7  
 f: +0/+0,5 (per esterni)  
 f: -0/-0,25 (per interni)  
 l1: k16  
 h1: js13

- 1 Il materiale degli utensili per interni ed esterni è: acciaio bonificato, durezza 43 HRC.
- 2 La testa degli utensili in metallo duro è in acciaio bonificato.
- 3 Il piano di appoggio degli utensili per esterni è rettificato.

Cerchio inscritto dell'inserto	6,35	7,94	9,525	12,7	15,875	19,05	25,4
Raggio r	0,4		0,8		1,2		2,4



## KINTEK车刀

## 技术参数

ISO5610外部车刀

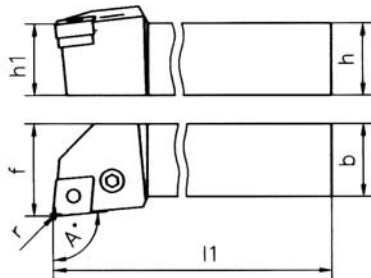

ISO5609内部车刀

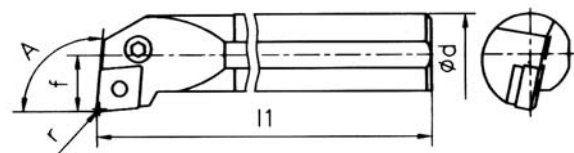

## 公差

h: h13  
 b: h13  
 d: g7  
 f: +0/+0,5 (External)  
 f: -0/-0,25 (Internal)  
 l1: k16  
 h1: js13

- 1 车刀内部和外部均由硬度为43HRC的硬化刚加工制成。
- 2 HM镗头柄头部由硬化钢构成
- 3 车刀端面外部打磨

Inscribed circle of the insert	6,35	7,94	9,525	12,7	15,875	19,05	25,4
Radius r	0,4		0,8		1,2		2,4

BEZEICHNUNG VON KLEMMHALTERN FÜR DIE AUSSENBEARBEITUNG  
IDENTIFICATION OF THE EXTERNAL (O.D.) TURNING TOOLS  
ДЕРЖАВКИ ДЛЯ ВНЕШНЕГО ТОЧЕНИЯ

DESIGNATION DES PORTE-PLAQUETTES EXTERIEURES  
IDENTIFICAZIONE DEI PORTA INSERTI PER ESTERNI  
外部车刀 (O.D.) 识别

① **M**

Spannsystem  
Clamping system  
Système de serrage  
Sistema di bloccaggio  
夹紧系统

② **W**

Plattenform  
Insert Shape  
Forme des plaquettes  
Forma degli inserti  
插件形状

③ **L**

Austellwinkel  
Shape of turning tools  
Forme des porte-plaquettes  
Forma dei portainseri  
车刀的形状

④ **N**

Freiwinkel  
Clearance angle  
Angle de depouil  
Angolo di spoglio  
间隙角度

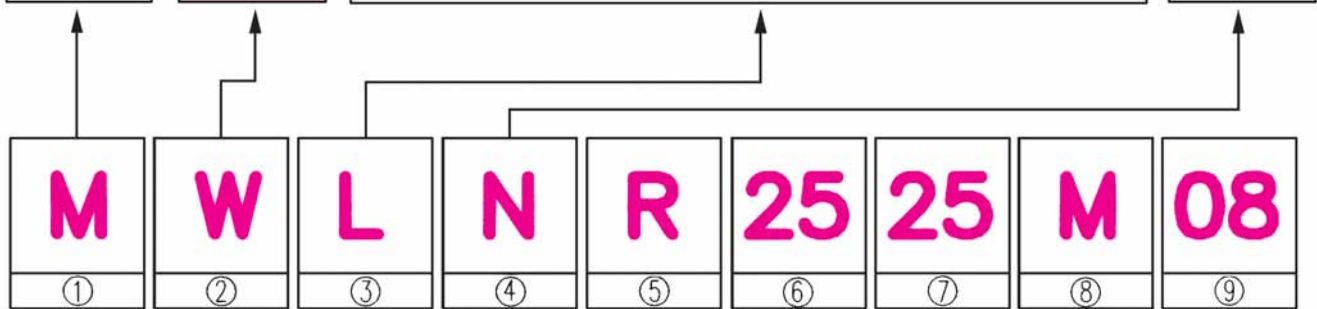
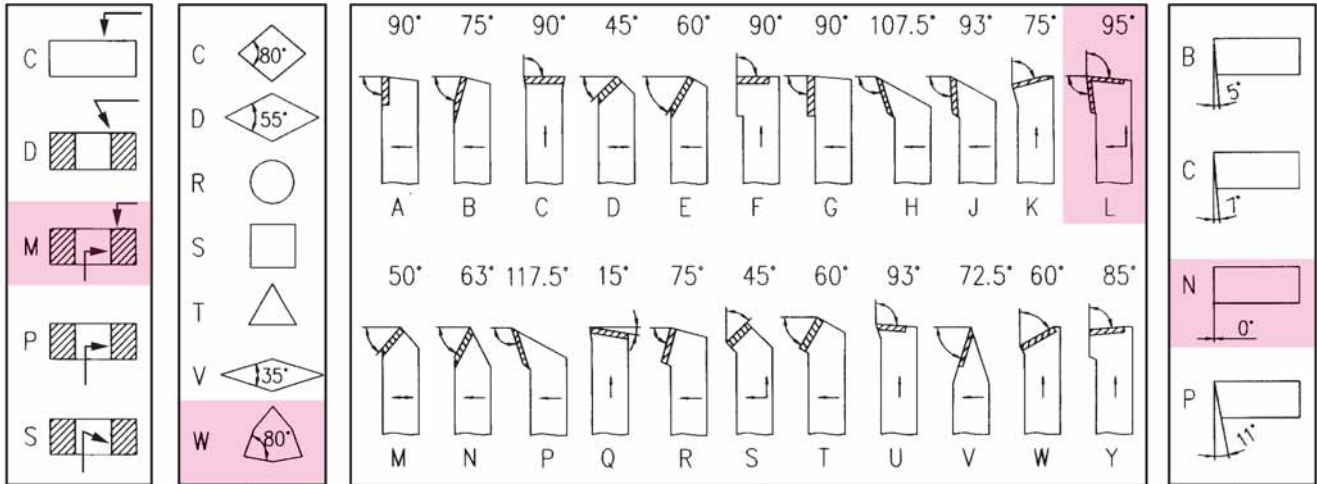

⑤ **R**

Vorshubrichtung  
Feeding direction  
Sens de l'avance  
Senso di avanzamento  
进给方向

⑥ **25**

Schafthöhe  
Shank height  
Hauteur des porte-plaquettes  
Altezza portainseri  
刀柄高度

⑦ **25**

Schaftbreite  
Shank width  
Largeur des porte-plaquettes  
Larghezza portainseri  
刀柄宽度

⑧ **M**

Werkzeuglänge  
Total length  
Longueur totale  
Lunghezza totale  
总长度

⑨ **08**

Schneidkantenlänge  
Insert cutting edge length  
Longueur des arêtes des plaquettes  
Lunghezza del profilo inserto  
插件的切削边缘长度

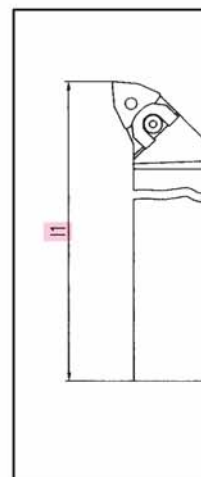
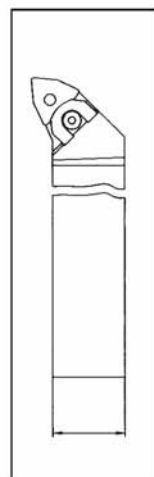
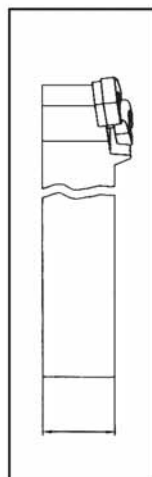
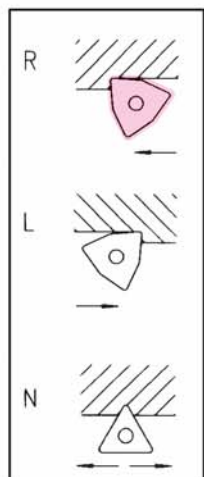

l1 (mm)		l1 (mm)	
A	32	M	150
B	40	N	160
C	50	P	170
D	60	Q	180
E	70	R	200
F	80	S	250
G	90	T	300
H	100	U	350
J	110	V	400
K	125	W	450
L	140	Y	500
		Z	600

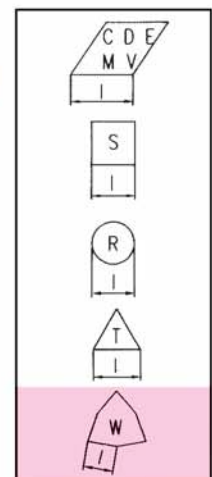

**MTEN**

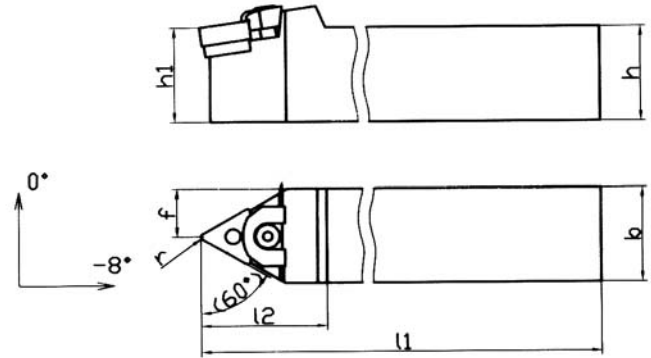

Code N.	h	b	l1	l2	h1	f	r	Inserts N.	Support pad	Clamp	Pin	Screw
MTENN 2525M16	25	25	150	33	25	12.5	0.8	TN..1604..				
MTENN 3225P16	32	25	170	33	32	12.5	0.8	TN..1604..				
MTENN 2525M22	25	25	150	35	25	12.5	0.8	TN..2204..				

**MTJN**

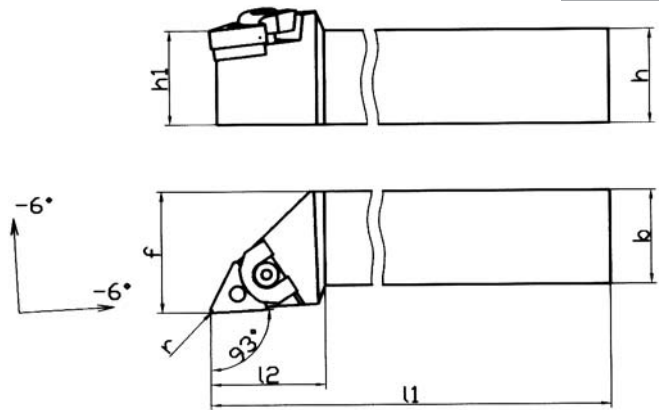

Code N.	h	b	l1	l2	h1	f	r	Inserts N.	Support pad	Clamp	Pin	Screw
MTJNR/L 2525M16	25	25	150	30	25	32	0.8	TN..1604..				
MTJNR/L 2525M22	25	25	150	35	25	32	0.8	TN..2204..				



### MWLN

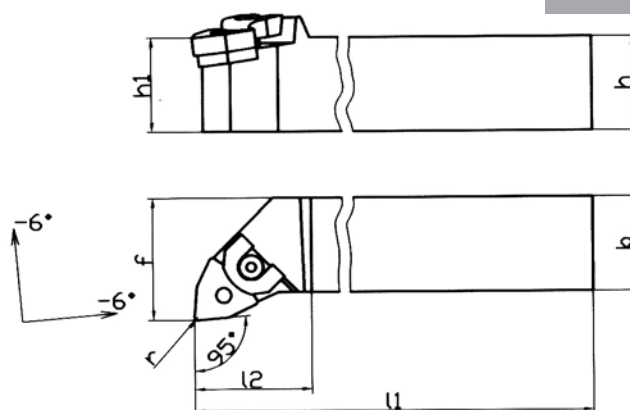

Code N.	h	b	l1	l2	h1	f	r	Inserts N.	Support pad	Clamp	Pin	Screw
MWLN/L 2020K08	20	20	125	31	20	25	0.8	WN..0804..				
MWLN/L 2525M08	25	25	150	31	25	32	0.8	WN..0804..				
MWLN/L 3225P08	32	25	170	31	32	32	0.8	WN..0804..				
MWLN/L 3232P08	32	32	170	31	32	40	0.8	WN..0804..				

### PCBN

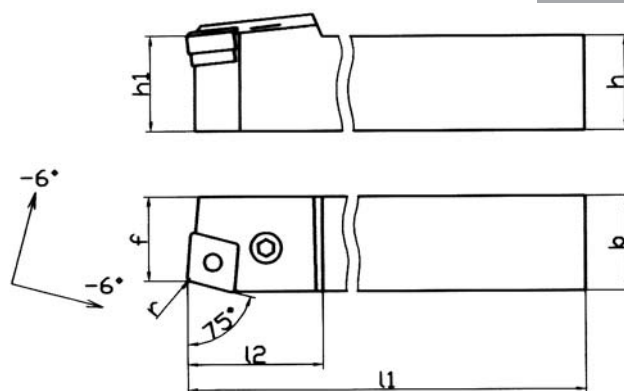

Code N.	h	b	l1	l2	h1	f	r	Inserts N.	Support pad	Shim pin	Lever	Screw
PCBN/L 2525M12	25	25	150	37	25	22	0.8	CNM.1204..				
PCBN/L 3225P12	32	25	170	37	32	22	0.8	CNM.1204..				
PCBN/L 2525M16	25	25	150	37	25	22	1.2	CNM.1606..				
PCBN/L 3232P19	32	32	170	43	32	27	1.2	CNM.1906..				
PCBN/L 4040S19	40	40	250	41	40	35	1.2	CNM.1906..				

**PCKN**

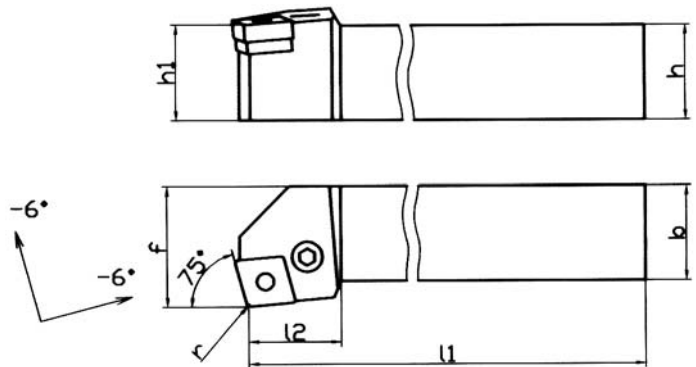

Code N.	h	b	l1	l2	h1	f	r	Inserts N.	Supportpad	Shim pin	Lever	Screw
PCKNR/L 2020K12	20	20	125	24	20	25	0.8	CNM.1204..	SPCN12	SP02	LV02	VT02
PCKNR/L 2525M12	25	25	150	26	25	32	0.8	CNM.1204..	SPCN12	SP02	LV02	VT02
PCKNR/L 3225P16	32	25	170	35	32	32	1.2	CNM.1606..	SPCN16	SP03	LV03	VT03
PCKNR/L 3225P19	32	25	170	35	32	32	1.2	CNM.1906..	SPCN19	SP09	LV04	VT04
PCKNR/L 3232P19	32	32	170	35	32	40	1.2	CNM.1906..	SPCN19	SP09	LV04	VT04

**PCLN**

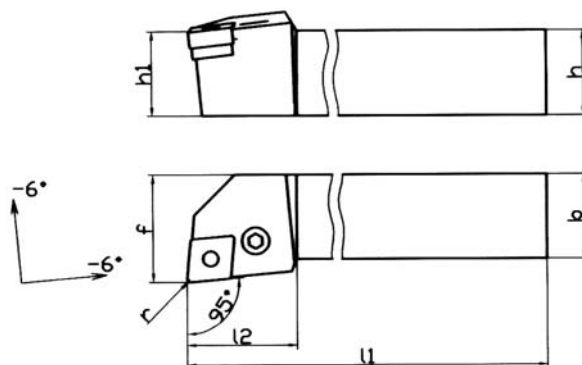

Code N.	h	b	l1	l2	h1	f	r	Inserts N.	Supportpad	Shim pin	Lever	Screw
PCLNR/L 1616H12	16	16	100	26	16	20	0.8	CNM.1204..	SPCN12	SP02	LV02	VT11
PCLNR/L 2020K12	20	20	125	28	20	25	0.8	CNM.1204..	SPCN12	SP02	LV02	VT02
PCLNR/L 2525M12	25	25	150	33	25	32	0.8	CNM.1204..	SPCN12	SP02	LV02	VT02
PCLNR/L 3225P12	32	25	170	33	32	32	0.8	CNM.1204..	SPCN12	SP02	LV02	VT02
PCLNR/L 3232P16	32	32	170	39	32	40	1.2	CNM.1606..	SPCN16	SP03	LV03	VT03
PCLNR/L 4040S16	40	40	250	39	40	50	1.2	CNM.1606..	SPCN16	SP03	LV03	VT03
PCLNR/L 2525M19	25	25	150	39	25	32	1.2	CNM.1906..	SPCN19	SP09	LV04	VT04
PCLNR/L 3225P19	32	25	170	39	32	32	1.2	CNM.1906..	SPCN19	SP09	LV04	VT04
PCLNR/L 3232P19	32	32	170	39	32	40	1.2	CNM.1906..	SPCN19	SP09	LV04	VT04
PCLNR/L 4040S19	40	40	250	39	40	50	1.2	CNM.1906..	SPCN19	SP09	LV04	VT04

### PDJN

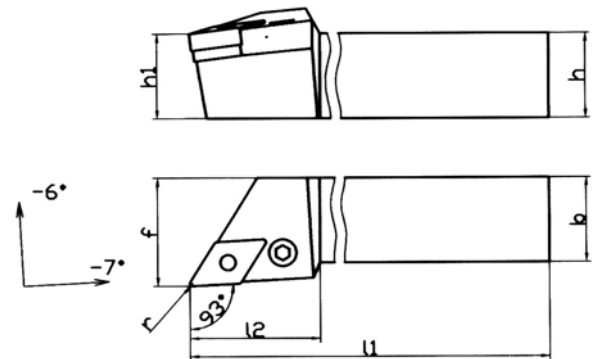

Code N.	h	b	l1	l2	h1	f	r	Inserts N.	Supportpad	Shim pin	Lever	Screw
PDJNR/L 2020K15	20	20	125	35	20	25	0.8	DNM.1506..				
PDJNR/L 2525M15	25	25	150	39	25	32	0.8	DNM.1506..				
PDJNR/L 3232P15	32	32	170	39	32	40	0.8	DNM.1506..				
PDJNR/L 4025R15	40	25	200	39	40	32	0.8	DNM.1506..				

### PDNN

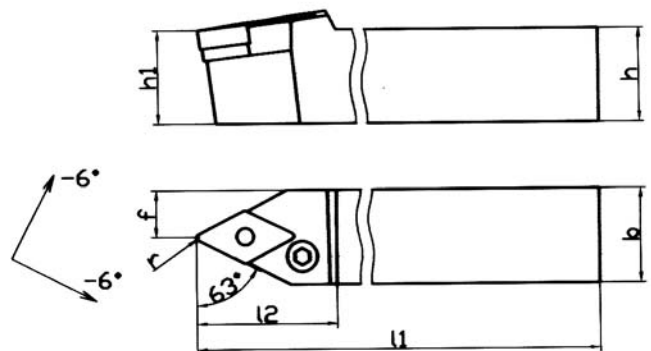

Code N.	h	b	l1	l2	h1	f	r	Inserts N.	Supportpad	Shim pin	Lever	Screw
PDNNR/L 2525M15	25	25	150	37	25	12.5	0.8	DNM.1506..				

PRDC

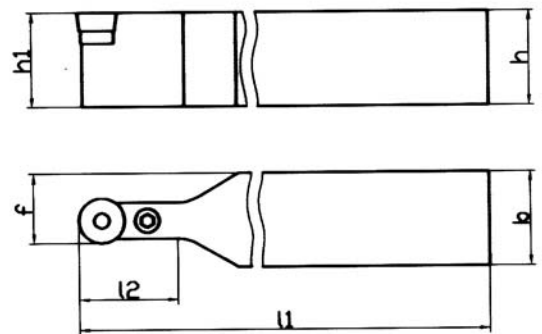

Code N.	h	b	l1	l2	h1	f	Inserts N.	Support pad	Shim pin	Lever	Screw
PRDCN 2525M10	25	25	150	21	25	17.5	RCM.100300.				
PRDCN 2525M12	25	25	150	26	25	18.5	RCM.120400.				

PSSN

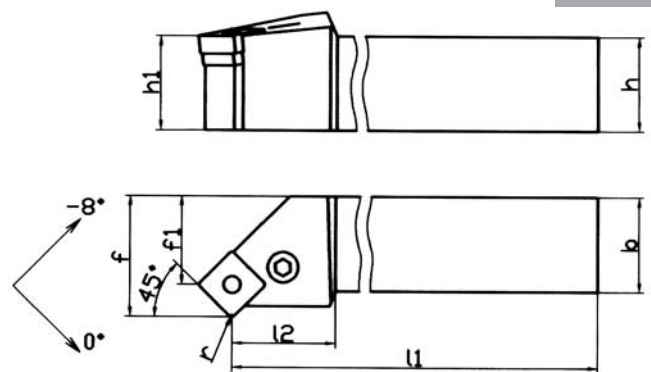

Code N.	h	b	l1	l2	h1	f	f1	r	Inserts N.	Support pad	Shim pin	Lever	Screw
PSSNR/L 2020K12	20	20	125	22	20	25	17	0.8	SNM.1204..				
PSSNR/L 2525M12	25	25	150	25	25	32	24	0.8	SNM.1204..				
PSSNR/L 2525M15	25	25	150	25	25	32	21	1.2	SNM.1506..				
PSSNR/L 3232P19	32	32	170	29	32	40	26	1.2	SNM.1906..				
PSSNR/L 4040S19	40	40	250	29	40	50	40	1.2	SNM.1906..				

### PWLN

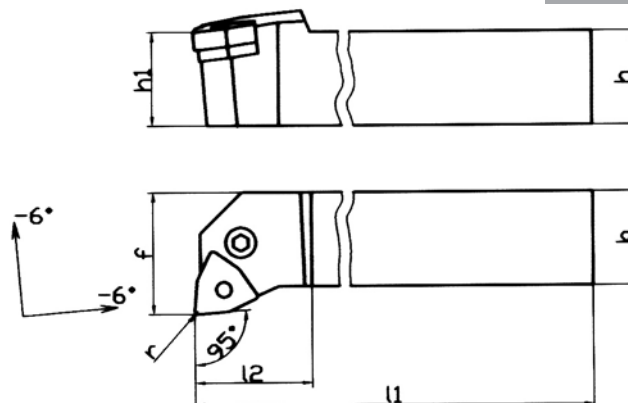

Code N.	h	b	l1	l2	h1	f	r	Inserts N.	Support pad	Shim pin	Lever	Screw
PWLNLR/L 2020K08	20	20	125	28	20	25	0.8	WN..0804..				
PWLNLR/L 2525M08	25	25	150	33	25	32	0.8	WN..0804..	SPWN08	SP02	LV02	VT02

### SCLC

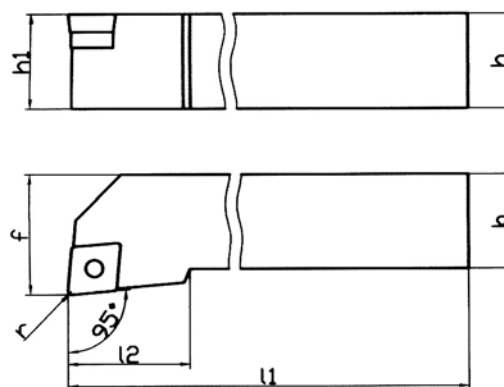

Code N.	h	b	l1	l2	h1	f	r	Inserts N.	Support pad	Bush	Screw
SCLCR/L 2020K09	20	20	125	29	20	25	0.8	CC..09T3..			
SCLCR/L 2020K12	20	20	125	29	20	25	0.8	CC..1204..	SPCC12	VTA01	TR4

**SDJC**

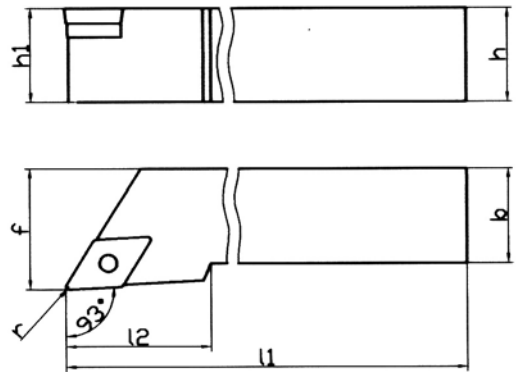

Code N.	h	b	l1	l2	h1	f	r	Inserts N.	Support pad	Bush	Screw
SDJCR/L 1212F11	12	12	80	29	12	16	0.8	DC..11T3..	-	-	TR14
SDJCR/L 1616H11	16	16	100	29	16	20	0.8	DC..11T3..	SPDC11	VTA02	TR8
SDJCR/L 2020K11	20	20	125	29	20	25	0.8	DC..11T3..	SPDC11	VTA02	TR8
SDJCR/L 2525M11	25	25	150	33	25	32	0.8	DC..11T3..	SPDC11	VTA02	TR8



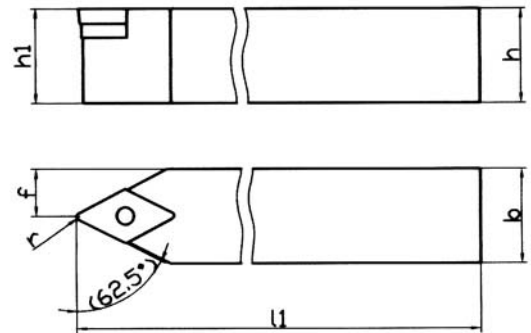



**SDNC**

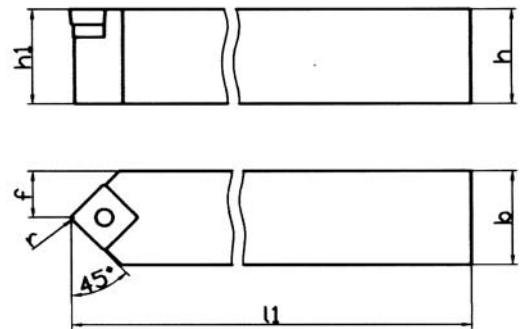

Code N.	h	b	l1	h1	f	r	Inserts N.	Support pad	Bush	Screw
SDNCN 1616H11	16	16	100	16	8	0.8	DC..11T3..	SPDC11	VTA02	TR8
SDNCN 2020K11	20	20	125	20	10	0.8	DC..11T3..	SPDC11	VTA02	TR8
SDNCN 2525M11	25	25	150	25	12.5	0.8	DC..11T3..	SPDC11	VTA02	TR8







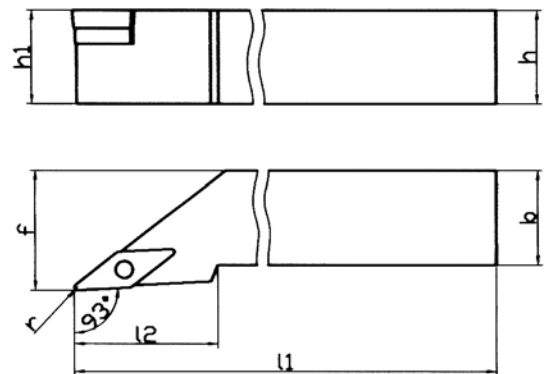

### SSDC



Code N.	h	b	l1	h1	f	r	Inserts N.	Support pad	Bush	Screw
SSDCN 1616H09	16	16	100	16	8	0.8	SCM.09T3..	 SPSC09	 VTA02	 TR8
SSDCN 2020K12	20	20	125	20	10	0.8	SCM.1204..	 SPSC12	 VTA01	 TR4

### SVJB



Code N.	h	b	l1	l2	h1	f	r	Inserts N.	Support pad	Bush	Screw
SVJBR/L 1616H11	16	16	100	29	16	20	0.4	VB..1102..	-	-	TR1
SVJBR/L 2020K11	20	20	125	29	20	25	0.4	VB..1102..	-	-	TR1
SVJBR/L 2525M11	25	25	150	29	25	32	0.4	VB..1102..	-	-	TR1
SVJBR/L 2020K16	20	20	125	35	20	25	0.8	VB..1604..	 SPVC16	 VTA02	 TR8
SVJBR/L 2525M16	25	25	150	35	25	32	0.8	VB..1604..	 SPVC16	 VTA02	 TR8
SVJBR/L 3225P16	32	25	170	35	32	32	0.8	VB..1604..	 SPVC16	 VTA02	 TR8

SVJC

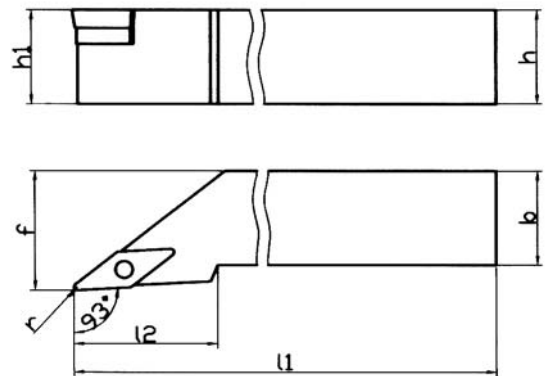

Code N.	h	b	l1	l2	h1	f	r	Inserts N.	Support pad	Bush	Screw
SVJCR/L 1212F11	12	12	80	23	12	16	0.4	VC..1103..			TR1
SVJCR/L 1616H11	16	16	100	23	16	20	0.4	VC..1103..	-	-	TR1
SVJCR/L 2020K11	20	20	125	23	20	25	0.4	VC..1103..	-	-	TR1
SVJCR/L 2020K16	20	20	125	34	20	25	0.8	VC..1604..	SPVC16	VTA02	TR8

SVHB

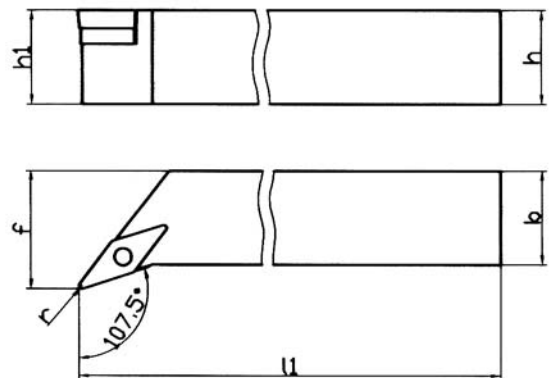



Code N.	h	b	l1	h1	f	r	Inserts N.	Support pad	Bush	Screw
SVHBR/L 2525M16	25	25	150	25	32	0.8	VB..1604..			TR8

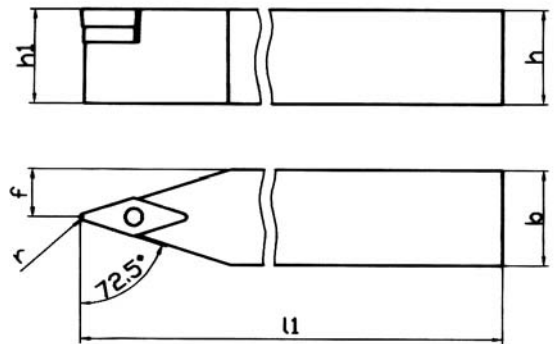

SVVB



Code N.	h	b	l1	h1	f	r	Inserts N.	Support pad	Bush	Screw
SWBN 2525M16	25	25	150	25	12.5	0.8	VB..1604..	 SPVC16	 VTA02	 TR8

BEZEICHNUNG VON KLEMMHALTERN FÜR INNENBEARBEITUNG  
IDENTIFICATION OF THE INTERNAL (I.D.) BORING TOOLS  
СИСТЕМА ОБОЗНАЧЕНИЯ РАСТОЧНЫХ ДЕРЖАВОК

DESIGNATION DES BARRES D'ALEPAGE INTERIEURES  
IDENTIFICAZIONE DEI BARENI PER INTERNI  
镗刀的内部标识

① **S**

Konstruktion  
Construction  
Construction  
Costruzione  
结构

② **25**

Klemmhalterdurchmesser  
Turning tools diameter  
Diametre des porte-plaquettes  
Diametro dei porta inserti  
车刀直径

③ **T**

Werkzeuglänge  
Total length  
Longueur totale  
Lunghezza totale  
总长

④ **P**

Spannsystem  
Clamping system  
Système de serrage  
Sistema di bloccaggio  
夹紧系统

A	Toll holder with oil hole Stell shank
C	Carbide shank
E	Toll holder with oil hole Carbide shank
S	Stell shank

	$\phi d$
08	$\phi 8$
10	$\phi 10$
12	$\phi 12$
16	$\phi 16$
20	$\phi 20$
25	$\phi 25$
32	$\phi 32$
40	$\phi 40$
50	$\phi 50$

l1 (mm)	
F	80
H	100
K	125
M	150
P	170
Q	180
R	200
X	225
S	250
T	300
U	350
V	400
W	450
Z	600

C	
M	
P	
S	

<b>S</b>	<b>25</b>	<b>T</b>	<b>P</b>	<b>D</b>	<b>U</b>	<b>N</b>	<b>R</b>	<b>11</b>
①	②	③	④	⑤	⑥	⑦	⑧	⑨

⑤ **D**

Plattform  
Insert Shape  
Forme des plaquettes  
Forma degli inserti  
插件形状

⑥ **U**

Austellwinkel  
Shape of turning tools  
Forme des porte-plaquettes  
Forma dei portainseriti  
车刀的形状

⑦ **N**

Freiwinkel  
Clearance angle  
Angle de depouil  
Angolo di spoglia  
间隙角度

⑧ **R**

Vorshubrichtung  
Freeding direction  
Sens de l'avance  
Senso di avanzamento  
进给方向

⑨ **11**

Schneidkantenlänge  
Insert cutting edge length  
Longueur des arêtes des plaquettes  
Lunghezza del profilo inserto  
插件的切削边缘长度

C	
D	
S	
T	
V	
W	

90°		F
75°		K
95°		L
117.5°		P
107.5°		Q
93°		U

B	
C	
N	
P	

R	
L	
N	

C D V I	
S I	
T I	
W I	

### MTFN

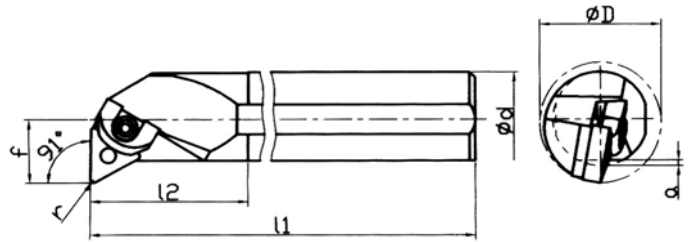
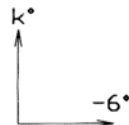
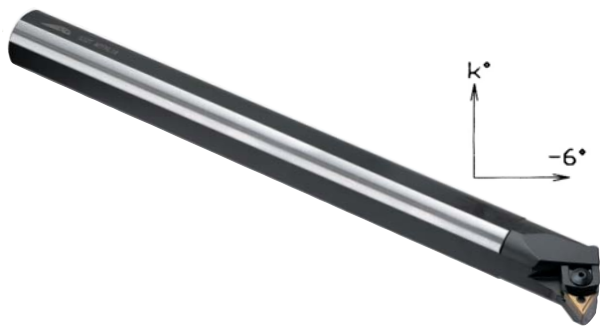

Code N.	d	l1	l2	f	a	K°	D	r	Inserts N.	Support pad	Clamp	Pin	Screw
S32TMTFNR/L22	32	300	55	22	2	-10	40	0.8	TN..2204..	MSPTN22	STF04	PER03	VT16

### MWLN

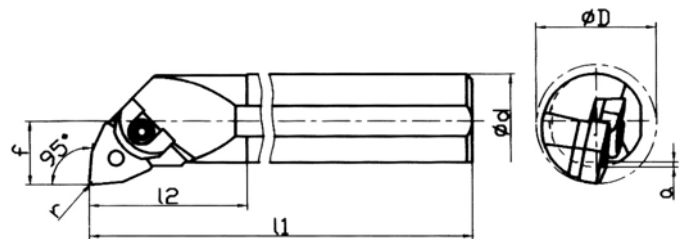
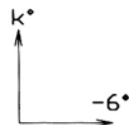

Code N.	d	l1	l2	f	a	K°	D	r	Inserts N.	Support pad	Clamp	Pin
S25SMWLNLR/L08	25	250	42	17	2	-12	32	0.8	WN..0804..	-	STF10	PER08
S32UMWLNLR/L08	32	350	49	22	2	-12	40	0.8	WN..0804..	MSPWN08	STF10	PER08
S40VMWLNLR/L08	40	400	56	27	2	-10	50	0.8	WN..0804..	MSPWN08	STF10	PER08
S50WMWLNLR/L08	50	450	63	35	2	-10	63	0.8	WN..0804..	MSPWN08	STF10	PER08

PCLN

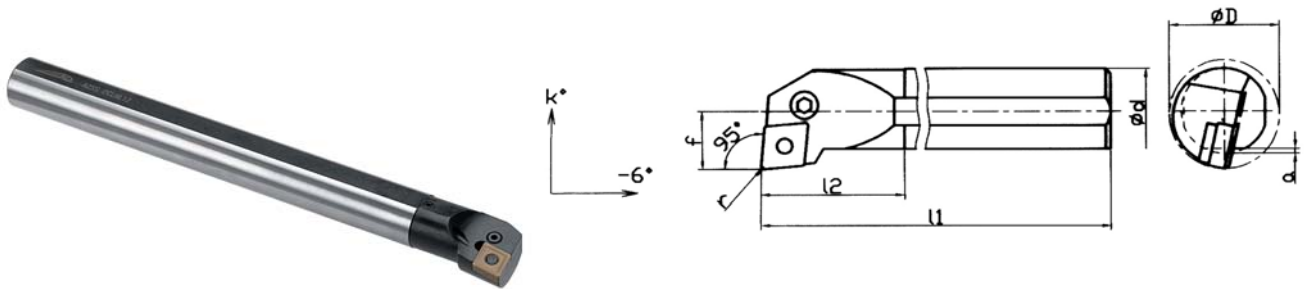

Code N.	d	l1	l2	f	a	K°	D	r	Inserts N.	Support pad	Shim pin	Lever	Screw
S25TPCLNR/L12	25	300	45	17	2	-12	32	0.8	CNM..1204..				
S32UPCLNR/L12	32	350	50	22	2	-10	40	0.8	CNM..1204..	SPCN12	SP02	LV02	VT02
S40VPCLNR/L12	40	400	60	27	2	-10	50	0.8	CNM..1204..	SPCN12	SP02	LV02	VT02
S40VPCLNR/L16	40	400	60	27	2	-10	50	1.2	CNM..1606..	SPCN16	SP03	LV03	VT03
S50WPCLNR/L16	50	450	75	35	2	-8	63	1.2	CNM..1606..	SPCN16	SP03	LV03	VT03
S50WPCLNR/L19	50	450	75	35	2	-8	63	1.2	CNM..1906..	SPCN19	SP04	LV04	VT04



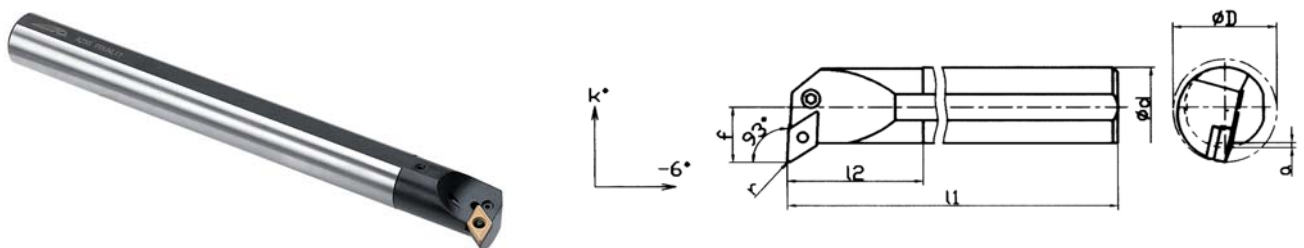

PDUN

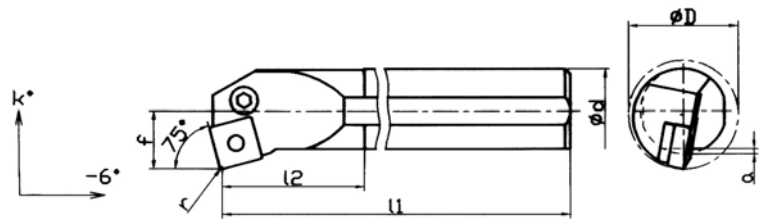

Code N.	d	l1	l2	f	a	K°	D	r	Inserts N.	Support pad	Shim pin	Lever	Screw
S32UPDUNR/L15	32	350	60	22	2	-15	40	0.8	DN..1506..				
S40VPDUNR/L15	40	400	60	27	2	-12	50	0.8	DN..1506..	SPDN15	SP02	LV05	VT05
S50WPDUNR/L15	50	450	70	35	2	-8	63	0.8	DN..1506..	SPDN15	SP02	LV05	VT05



### PSKN

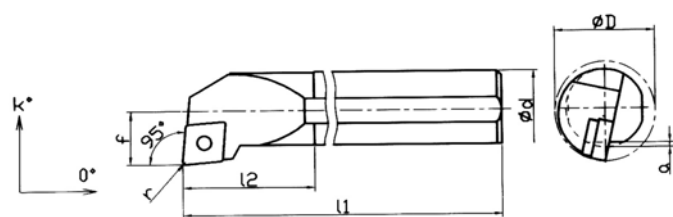

Code N.	d	l1	l2	f	a	K°	D	r	Inserts N.	Support pad	Shim pin	Lever	Screw
S32UPSKNR/L12	32	350	57	22	2	-10	40	0.8	SN..1204..				
S40VPSKNR/L15	40	400	57	27	2	-10	50	1.2	SN..1506..	SPSN12	SP02	LV02	VT02
S50WPSKNR/L19	50	450	70	35	2	-10	63	1.2	SN..1906..	SPSN15	SP03	LV03	VT03
										SPSN19	SP09	LV04	VT04

### SCLC



Code N.	d	l1	l2	f	a	K°	D	r	Inserts N.	Support pad	Bush	Screw
S08HSCLCR/L06	8	100	25	6	0.5	-12	11	0.4	CC..0602..			
S10KSCLCR/L06	10	125	25	7	0.5	-10	13	0.4	CC..0602..	-	-	TR1
S12MSCLCR/L06	12	150	30	9	0.5	-10	16	0.4	CC..0602..	-	-	TR1
S16RSCLCR/L06	16	200	40	11	1	-10	20	0.4	CC..0602..	-	-	TR1
S16RSCLCR/L09	16	200	40	11	1	-10	20	0.8	CC..09T3..	-	-	TR12
S20SSCLCR/L09	20	250	40	13	1.5	-8	25	0.8	CC..09T3..	-	-	TR14
S25TSCLCR/L12	25	300	50	17	2	-5	32	0.8	CC..1204..	-	-	TR13
S32USCLCR/L12	32	350	60	22	2	-5	40	0.8	CC..1204..	SPCC12	VTA01	TR4
S40VSCLCR/L12	40	400	60	27	2	-5	50	0.8	CC..1204..	SPCC12	VTA01	TR4

## SDUC

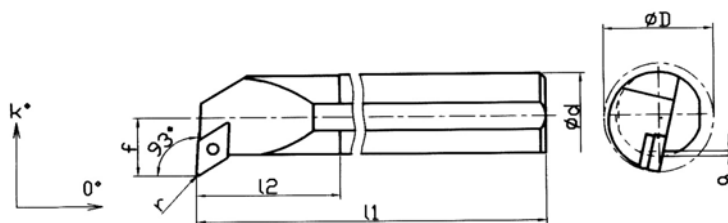

Code N.	d	l1	l2	f	a	K°	D	r	Inserts N.	Support pad	Bush	Screw
S10KSDUCR/L07	10	125	25	7	0.5	-10	13	0.4	DC..0702..	-	-	TR1
S12MSDUCR/L07	12	150	25	9	0.5	-10	16	0.4	DC..0702..	-	-	TR1
S16RSDUCR/L07	16	200	40	11	1	-10	20	0.4	DC..0702..	-	-	TR1
S20SSDUCR/L11	20	250	40	13	1.5	-8	25	0.8	DC..11T3..	-	-	TR12
S25TSDUCR/L11	25	300	45	17	2	-5	32	0.8	DC..11T3..	-	-	TR14
S32USDUCR/L11	32	350	60	22	2	-5	40	0.8	DC..11T3..	SPDC11	VTA02	TR8

## STFC

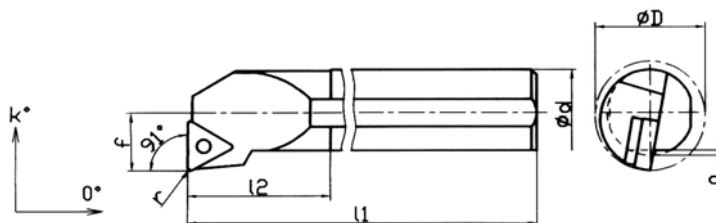

Code N.	d	l1	l2	f	a	K°	D	r	Inserts N.	Support pad	Bush	Screw
S10KSTFCR/L11	10	125	28	7	0.5	-12	13	0.4	TC..1102..	-	-	TR1
S16RSTFCR/L11	16	200	40	11	1	-8	20	0.4	TC..1102..	-	-	TR1
S20SSTFCR/L16	20	250	45	13	1.5	-8	25	0.8	TC..16T3..	-	-	TR14
S25TSTFCR/L16	25	300	50	17	2	-5	32	0.8	TC..16T3..	-	-	TR14
S32USTFCR/L16	32	350	50	22	2	-5	40	0.8	TC..16T3..	SPTC16	VTA02	TR8
S40VSTFCR/L16	40	400	60	27	2	-5	50	0.8	TC..16T3..	SPTC16	VTA02	TR8