

ROBOHAND™

AUTOMATION PRODUCTS

GRIPPERS, SLIDES, ROTARIES

destaco.com

VISUAL SELECTION GUIDE

MARKETS



CONSUMER GOODS



FOOD & PACKAGING



INDUSTRIAL



LIFE SCIENCES



LOGISTICS



AUTOMOTIVE

NORTH AMERICAN XPRESS PROGRAM

A Full Line of Automation Products to Meet Your Application Needs Quickly









ON OUR MOST POPULAR PRODUCTS

To choose the best and most cost-effective automation solution for your application please contact your DESTACO sales representative or DESTACO customer service.

Product listed below are for North American Market only.

Parallel Grippers



	HEAVY DUTY	RDH/RTH Series 2 & 3 Jaw Impact Resistant Shielded Gripper	1, 2, 3, 4, 5 -L Stroke option	4.0-26	125-675
	HEAVY DUTY	RP Series Rugged Impact Resistant Gripper	5, 10, 11, 12, 15	4.0-12.7	156-311
		RPL/RPLC Series Zero Side Play, High Repeatability Gripper	1, 2, 3, 4 (C)=Clean Room Version	6.4-25.4	116-160
		RPM/RPMC Series Low Friction Micro Gripper	1, 2, 3, (C)=Clean Room Version	4.1-6.3	36
		DPG Series Modular Multi-Part Sensing Gripper	10M-2	12.7	222
	HEAVY DUTY	DPW Series Wide Parts/ Long Finger Gripper	250, 375, 500	19.05-63.5	222-800
	HEAVY DUTY	RPW Series Wide Parts/ Long Finger Gripper	625	50.8-88.9	1068

Angular Grippers



RA Series
Low Cost Small Size Angular Gripper

RA-5

15°
(per finger)

89

Rotary Actuators



RR Series
High Torque Compact Rotary Actuators

18, 28, 36

0-180°

0.45-3.6

EUROPEAN XPRESS PROGRAM

A Full Line of Automation Products to Meet Your Application Needs Quickly



ON OUR MOST POPULAR PRODUCTS

To choose the best and most cost-effective automation solution for your application please contact your DESTACO sales representative or DESTACO customer service.

Product listed below are for European Market only.



SIZE















STROKE [mm]



FORCE [N]

2-Jaw Parallel Grippers

	HEAVY DUTY RDH Series Impact Resistant Shielded Gripper	All Sizes	4-70	361-28002
	2P Series Precision Cylindrical Gripper	All Sizes	10-30	109-3043
	REP-2 Series Cylindrical Shielded Gripper	All Sizes	10-30	480-3351
	DGC Series Precision Long Stroke Gripper	All Sizes	20-60	474-2318
	DPG Series Modular Gripper	All Sizes	6.4-25.4	222
	DPW Series Wide Parts/ Long Finger Gripper	All Sizes	19.1-63.5	222-800
	HEAVY DUTY RPW Series Wide Parts/ Long Finger Gripper	625, 750	19.1-114.3	222-2091
	HEAVY DUTY RP Series Rugged Impact Resistant Gripper	All Sizes	4.0-50.8	40-3336
	DPL Series Long Stroke, Low Profile Gripper	All Sizes	40-140	811-2035
	CP Series Compact Gripper	All Sizes	4-32	10-2749
	RPL/RPLC Series Zero Side Play, High Repeatability Gripper	All Sizes (C)=Clean Room	6.4-25.4	116-160
	RPM/RPMC Series Low Friction Micro Gripper	All Sizes (C)=Clean Room	3.2-6.3	36
	RDE Series Water Immersion Gripper	Contact DESTACO for More Information		

EUROPEAN XPRESS PROGRAM

A Full Line of Automation Products to Meet Your Application Needs Quickly



FAST LOCAL DELIVERY

ON OUR MOST POPULAR PRODUCTS

To choose the best and most cost-effective automation solution for your application please contact your DESTACO sales representative or DESTACO customer service.

Product listed below are for European Market only.

3-Jaw Parallel Grippers



SIZE



STROKE [mm]



FORCE [N]

 	HEAVY DUTY RTH Series Impact Resistant Shielded Gripper	All Sizes	4-20	579-4562
	3P Series Precision Cylindrical Gripper	All Sizes	10-30	107-2030
	REP-3 Series Cylindrical Shielded Gripper	All Sizes	10-30	469-3268
	PPC Series Thru-Hole Gripper	All Sizes	10-30	896-4332
	RTE Series Water Immersion Gripper	Contact DESTACO for More Information		

Angular Grippers



SIZE



ANGLE



FORCE [N]

 	RUA Series Cylindrical Gripper	All Sizes	15.9-19.1° (per finger)	313-3941
	DCT-CT Series 180° Jaw Opening Gripper	All Sizes	90° (per finger)	32-893
	RA Series Compact Gripper	RA-6	15° (per finger)	71-801
	FUA Series Food Gripper	All Sizes	35° (per finger)	9-32

EUROPEAN XPRESS PROGRAM

A Full Line of Automation Products to Meet Your Application Needs Quickly



ON OUR MOST POPULAR PRODUCTS

To choose the best and most cost-effective automation solution for your application please contact your DESTACO sales representative or DESTACO customer service.

Product listed below are for European Market only.

Rotary Actuators



		SIZE	ANGLE	PAYLOAD [Kg]
	RR Series Light-Duty High Torque Compact Rotary Actuators	All Sizes	0-180°	0.45-1.3
 HEAVY DUTY	RR Series Heavy-Duty High Torque Compact Rotary Actuators	All Sizes	0-180°	3.6-91





Feed Escapements

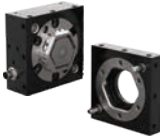

		SIZE	STROKE [mm]	PARTS ESCAPED
	RFE Series 2-Finger Actuation	All Sizes	16-32	85-150 (per minute)

Tool Changers and Compliance

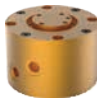

		SIZE	PORTS	PAYLOAD [Kg]
 HEAVY DUTY	RQC/RTP Series Heavy-Duty Tool Changer	All Sizes	19 pin Electrical and 6 Pneumatic Ports	90-550
	QC/TP Series Tool Changer	All Sizes	12-15 pin Electrical and 4 Pneumatic Ports	30-150
	CH Series Horizontal Compliance	All Sizes	N/A	2-40
	AU Series Resettable Emergency Stop Module	Contact DESTACO for More Information		

ROBOTIC TOOLING SOLUTIONS

CLICK OR SCAN

To view full catalog pages on these product

Automatic Tool Changers | Features and Benefits

Automatic Tool Changers

Robotic Applications:

Perfect for those flexible/multiple tooling applications utilizing one Robot. This product was designed with exceptional repeatability, high rigidity & load capacity to make it ideal for any robotic application.

Automation Applications:

End effector tooling and interchangeable fixturing can be changed quickly and easily to accommodate many different styles of parts on the same assembly machine or machining center.

Highly Configurable, Modular Design (RQC/RTP):

The Modular RQC series easily accommodates up to (4) optional modular interfaces, offering a high level of flexibility.

Mounting Information

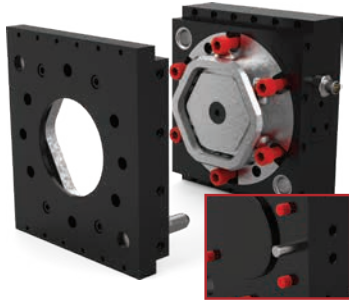

RQC Robot Plate Adaptor

Counterbored holes for mounting with a dowel pin hole, a raised boss for location and a ISO9409-1 mounting pattern.

Back Side of RQC

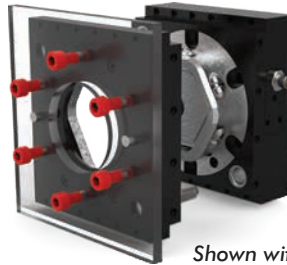

RTP Tool Plate Adaptor

Tapped holes, two dowel pin holes for accurate location of payload and a ISO9409-1 mounting pattern.

Shown with customer supplied adapter plate.



QC Robot Plate Adaptor

has counterbored holes for mounting and two dowel pins for hole location (size 30 has pilot boss).



TP Tool Plate Adaptor

has counterbored holes for mounting and two dowel pins for hole location (size 30 has pilot boss).

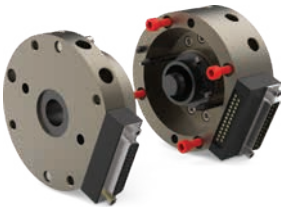

RHC Robot Plate Adaptor

mounts with screws from behind or through the front and locates with dowel pins for accuracy.

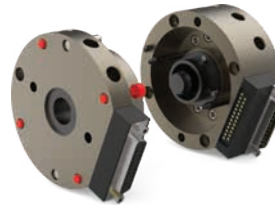

RHC Tool Plate Adaptor

mounts payload with screws from behind or through the front and locates with dowel pins for accuracy. Protect cone surfaces from debris to insure proper positioning.



Compliance Device | Features and Benefits

Flexibility of the Tool:

Cylindrical Horizontal compliance devices are used for inserting components that may be misaligned with the tool. They allow a horizontal displacement that compensates for part placing inaccuracies.

For Precision Applications:

High quality components allows for centering repeatability from 0.02mm and angular repeatability from $\pm 10^\circ$.

Harsh Environments:

Enclosed design allows them to be used in harsh environments.

Spring Assist:

Optional spring assist allows for use in single acting mode.



Mounting Information



CH Horizontal Compliance

The compliance is located using a pilot boss and a dowel pin and assembled using 4 or 6 through body screws.

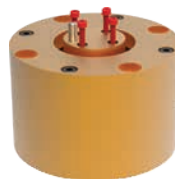

Tool Mounting

Tooling is located using a centering and a dowel pin and assembled using 4 screws.



See pages 5-8 for product availability in your region.



CLICK OR SCAN

To view full catalog pages on this product

RQC/RTP SERIES

Automatic Tool Changers | Technical Information

RQC-200/RTP-200

Combined Weight: 3 Kg [6.7 lb]
Max. Payload*: 90 Kg [200 lb]
Max. Moment: 810 Nm [7200 in-lb]

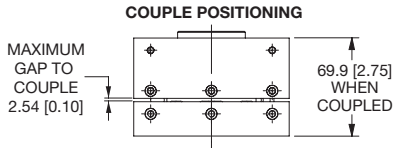

RQC-200 Robot Plate
RTP-200 Tool Plate



See pages 5-8 for product availability in your region.

RQC-400/RTP-400

Combined Weight: 4.7 Kg [10.4 lb]
Max. Payload*: 180 Kg [400 lb]
Max. Moment: 1580 Nm [14000 in-lb]

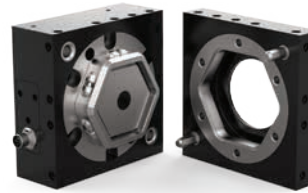
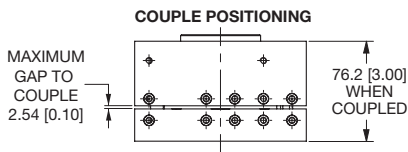

RQC-400 Robot Plate
RTP-400 Tool Plate

RQC-800/RTP-800

Combined Weight: 7.1 Kg [15.8 lb]
Max. Payload*: 360 Kg [800 lb]
Max. Moment: 2490 Nm [22000 in-lb]

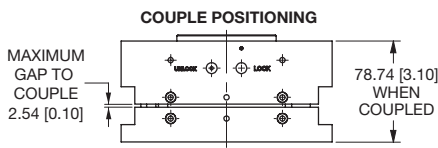

RQC-800 Robot Plate
RTP-800 Tool Plate

RQC-1200/RTP-1200

Combined Weight: 8.3 Kg [18.4 lb]
Max. Payload*: 550 Kg [1200 lb]
Max. Moment: 3390 Nm [30000 in-lb]

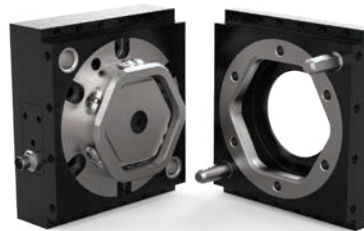
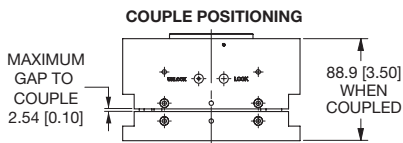

RQC-1200 Robot Plate
RTP-1200 Tool Plate

RQC-2400/RTP-2400

Combined Weight: 30 Kg [66.1 lb]
Max. Payload*: 1089 Kg [2400 lb]
Max. Moment: 7000 Nm [61955 in-lb]

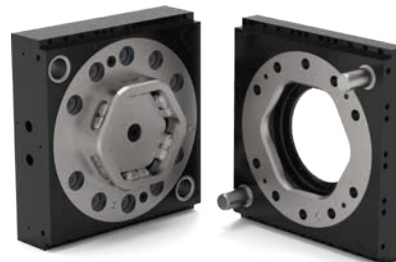
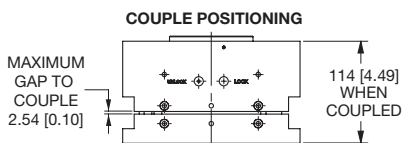

RQC-2400 Robot Plate
RTP-2400 Tool Plate

*Depending on your application parameters please contact DESTACO for validation.

QC/TP, RHC SERIES

Automatic Tool Changers | Features and Benefits

CLICK OR SCAN

To view full catalog pages on these product

QC Series Tool Changers



See page 5-8 for product availability in your region.



RHC Series Tool Changers



QC-30

Robot Plate



TP-30

Tool Plate

Combined Weight: 0.34 Kg [0.75 lbs]
Max. Payload: 13.6 Kg [30 lbs]
Max. Moment: 22.6 Nm [200 in-lbs]

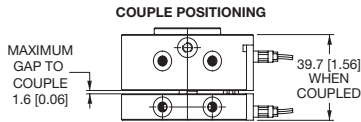

RHC-1-R

Robot Plate



RHC-1-T

Tool Plate

Combined Weight: 0.29 Kg [0.63 lbs]
Max. Payload: 9 Kg [20 lbs]
Max. Moment: 28 Nm [250 in-lbs]

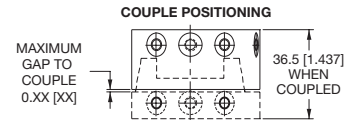

QC-60

Robot Plate



TP-60

Tool Plate

Combined Weight: 1.27 Kg [2.8 lbs]
Max. Payload: 27 Kg [60 lbs]
Max. Moment: 88.1 Nm [780 in-lbs]

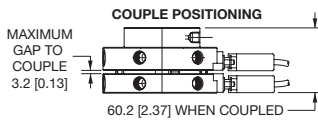

RHC-2-R

Robot Plate



RHC-2-T

Tool Plate

Combined Weight: 0.82 Kg [1.81 lbs]
Max. Payload: 59 Kg [130 lbs]
Max. Moment: 136 Nm [1200 in-lbs]

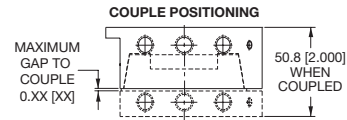

QC-60-10P

Robot Plate



TP-60-10P

Tool Plate

Combined Weight: 1.27 Kg [2.8 lbs]
Max. Payload: 27 Kg [60 lbs]
Max. Moment: 88.1 Nm [780 in-lbs]

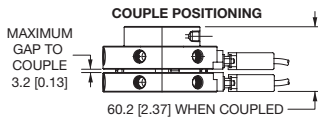

RHC-4-R

Robot Plate



RHC-3-T

Tool Plate

Combined Weight: 3.1 Kg [6.8 lbs]
Max. Payload: 136 Kg [300 lbs]
Max. Moment: 1017 Nm [9000 in-lbs]

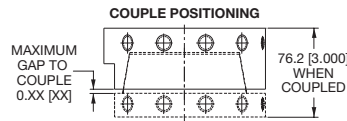

QC-150

Robot Plate



TP-150

Tool Plate

Combined Weight: 3.2 Kg [7.1 lbs]
Max. Payload: 68 Kg [150 lbs]
Max. Moment: 215 Nm [1900 in-lbs]

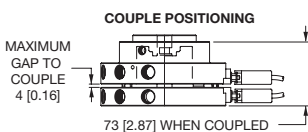

RHC-4-R

Robot Plate



RHC-4-T

Tool Plate

Combined Weight: 11 Kg [24.3 lbs]
Max. Payload: 454 Kg [1000 lbs]
Max. Moment: 2825 Nm [25000 in-lbs]

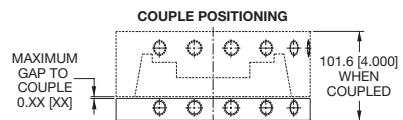

DPE-400 HEAVY-DUTY

Electric Parallel Grippers

How To Order

CLICK OR SCAN
To view full
catalog pages
on this product

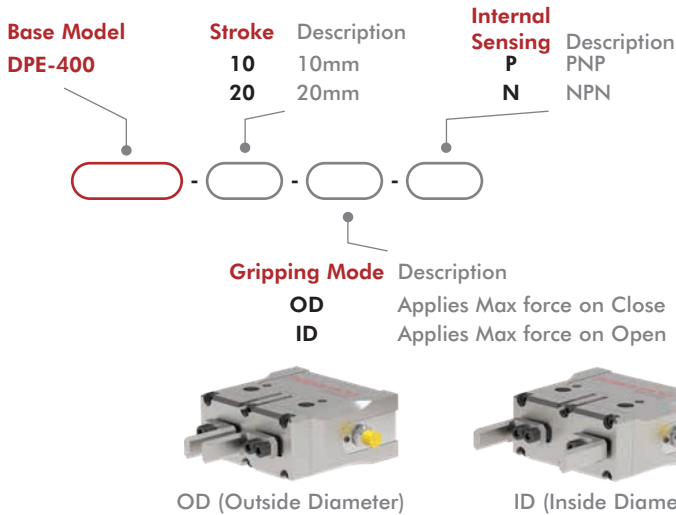

Shown with customer supplied fingers.

Basic Unit Dimensions

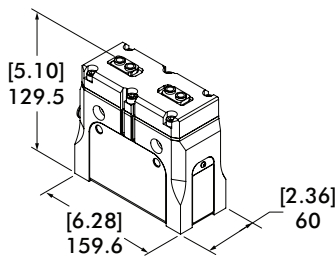

Accessories

Power and Sensor Accessories	Part Number
PNP Magneto-Resistive Position Sensor	OHSP-017
NPN Magneto-Resistive Position Sensor	OHSN-017
Quick Disconnect Sensor Cable, 5m long	CABL-013
8-wire Power and Signal Cable, 5m long w/Straight M12 Connector	CABL-052
8-wire Power and Signal Cable, 5m long w/90° M12 Connector	CABL-053

* Sensor and cable sold separately.

Specifications	Units	DPE-400
Total Rated Grip Force:		
DPE-400-10	N [lbf]	667-1334 [150-300]
DPE-400-20	N [lbf]	445-890 [100-200]
Total Stroke:		
DPE-400-10	mm [in]	10 [0.39]
DPE-400-20	mm [in]	20 [0.78]
Actuation Time	ms	800
Temperature Range	°C [°F]	0~55° [32°~131°]
Power Requirements @ 100% Duty Cycle	watts	10
Voltage	VDC	24
DC Current (Peak)	amps	2 (max)
DC Current: (Continuous)	amps	0.4
Ingress Protection Class (IP)		IP50
Clean Room		100 (Magnalube)
Weight	kg [lbs]	2.52 [5.56]
Maximum Finger Length	mm [in]	125 [4.92]
Durability	cycles	3 Million

2P SERIES

2-Jaw Precision Parallel Grippers

How To Order

CLICK OR SCAN
To view full
catalog pages
on this product



See page 5-8 for product availability in your region.



Note: See catalog for complete options information.

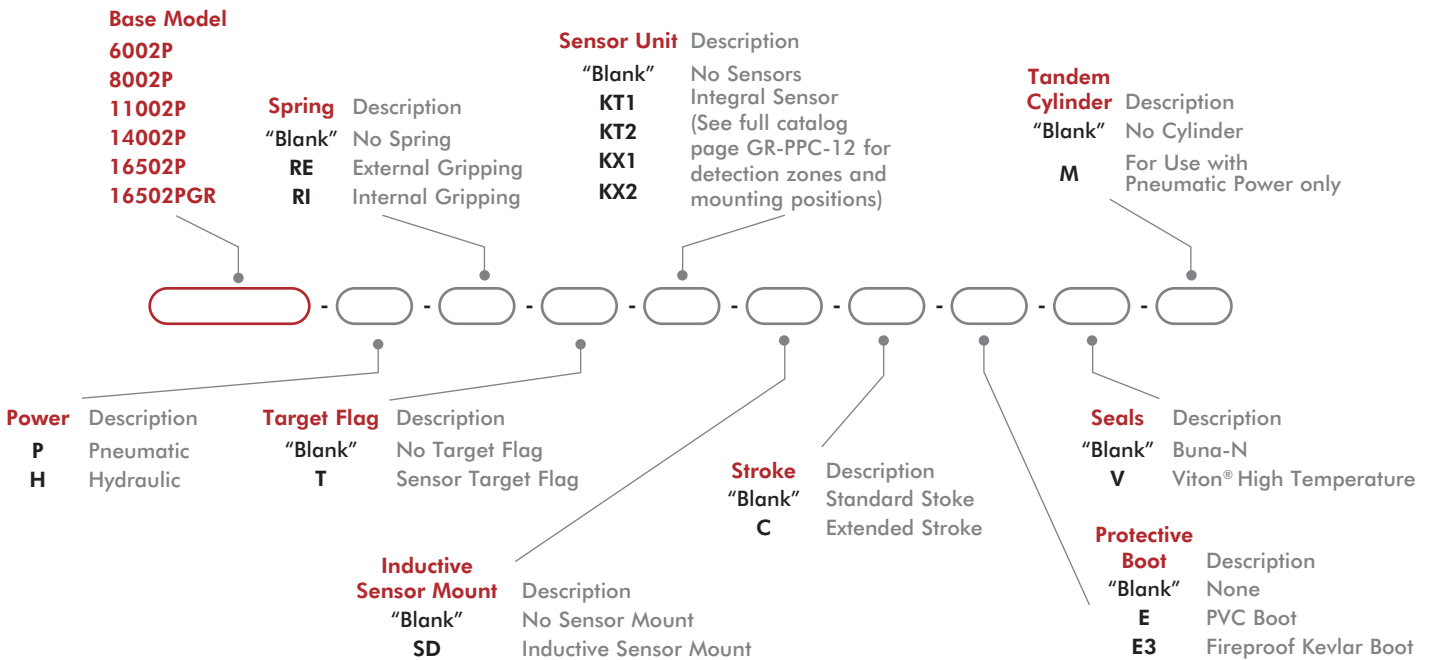

Size	Seal Repair Kits			Protective Boots	
	Buna-N	Viton®	Hydraulic	PVC - Brown or Black	Fireproof KEVLAR - Red
6002P	SLKT-156	SLKT-156V	SLKT-330	ER62P	E3R62P
8002P	S80	S80V	S80H	ER82P	E3R82P
11002P	S100	S110V	S110H	ER112P	E3R112P
14002P	SLKT-333	SLKT-333	SLKT-334	KP-311	KP-313
16502P	SLKT-335	SLKT-335V	SLKT-336	KP-314	KP-316
16502PGR				N/A	KENVE2-21384

DGC/GC SERIES

2-Jaw Precision Parallel Grippers

How To Order

CLICK OR SCAN
To view full
catalog pages
on this product



See page 5-8 for product availability in your region.

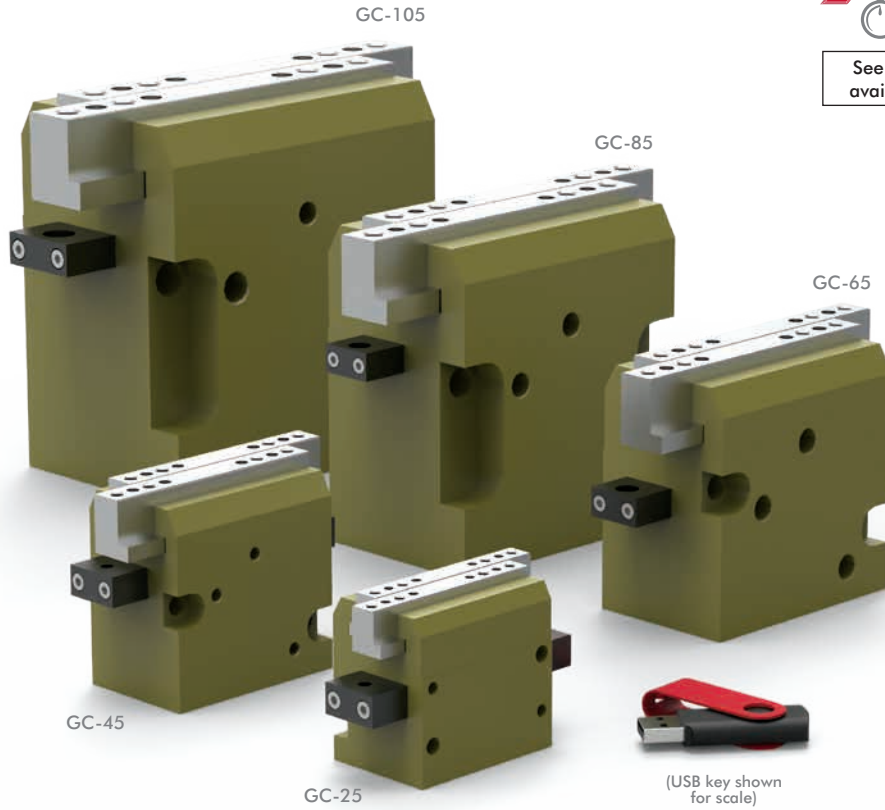

Base Model

- DGC-25 GC-85
- DGC-45 GC-105
- DGC-65

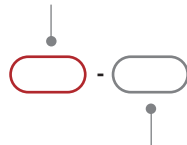

- | | |
|--------------|-------------------------|
| Seals | Description |
| "Blank" | Buna-N |
| V | Viton® High Temperature |

Size	Seal Repair Kits	
	Buna-N	Viton®
25	SLKT-319	SLKT-319V
45	SLKT-321	SLKT-321V
65	SLKT-323	SLKT-323V
85	SLKT-325	SLKT-325V
105	SLKT-327	SLKT-327V

DPL SERIES

2-Jaw Precision Parallel Grippers

How To Order

CLICK OR SCAN
To view full
catalog pages
on this product



See page 5-8 for product availability in your region.

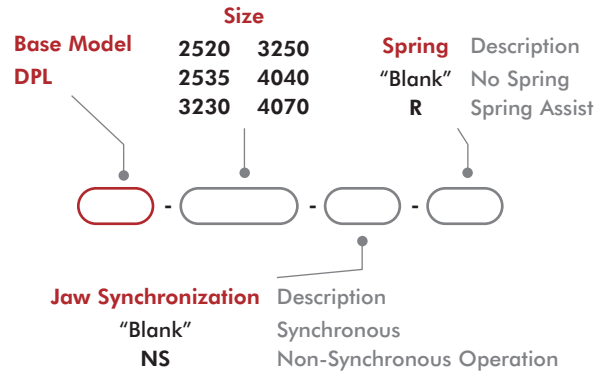
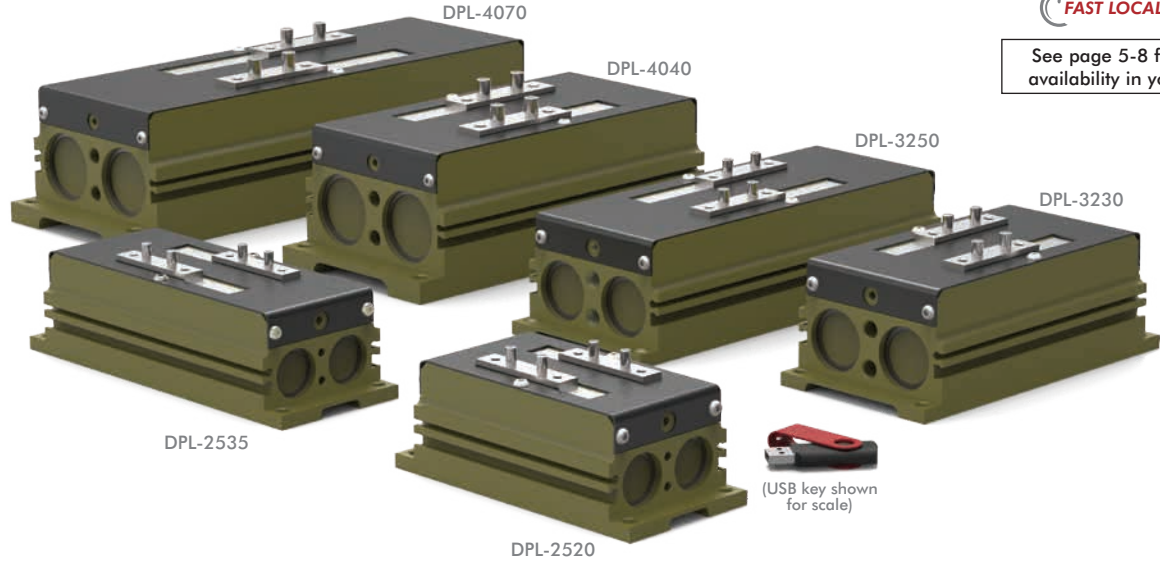

Size	Seal Repair Kit Buna-N	Rear Inlet Seal Repair Kit	In-line Jaw Mounting Kit	Inductive Sensor Mtg Kit (3 Holder/2 Flags)
2520	SLKT-233	SLKT-316	ODPL-001	OSMK-099
2535			ODPL-002	
3230	SLKT-234		ODPL-003	OSMK-100
3250	ODPL-004			
4040	SLKT-235		ODPL-005	OSMK-101
4070			ODPL-006	

Basic Unit Dimensions

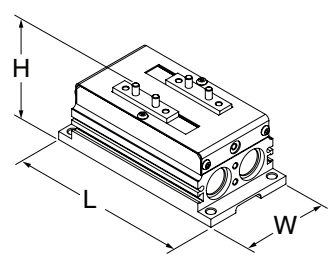

Size	L	W	H
2520	152 [5.98]	75 [2.95]	65 [2.56]
2535	197 [7.76]		65 [2.56]
3230	186 [7.32]	93 [3.66]	74 [2.91]
3250	246 [9.69]		
4040	238 [9.37]	112 [4.41]	91 [3.58]
4070	328 [12.91]		

DPP SERIES

2-Jaw Precision Parallel Grippers

How To Order

CLICK OR SCAN
To view full
catalog pages
on this product

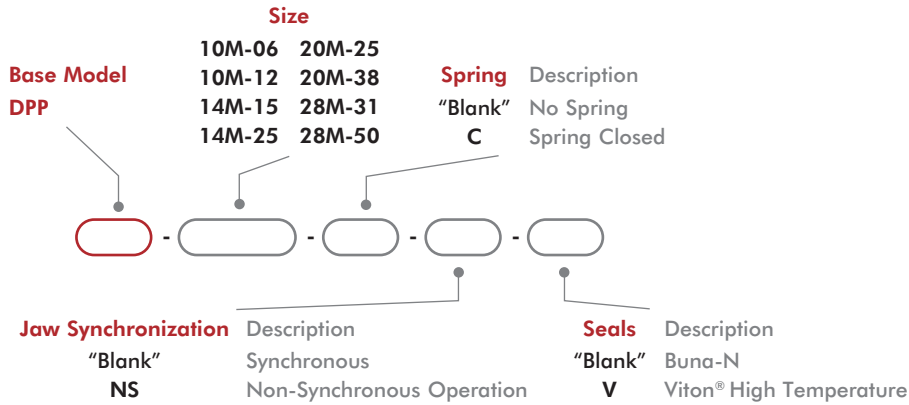
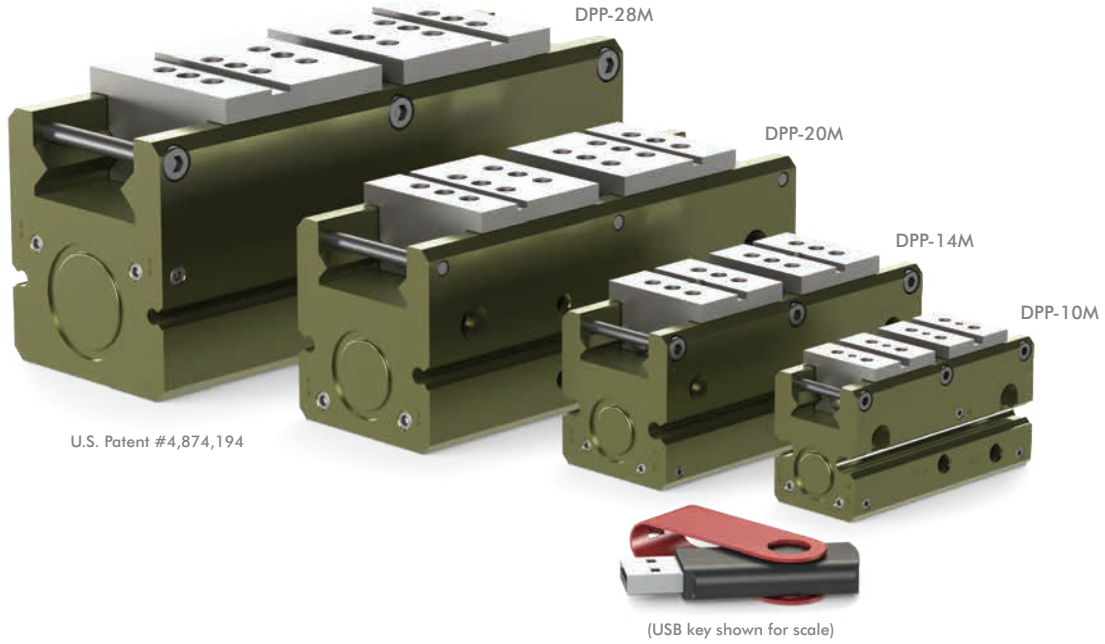

Size	Seal Repair Kits		
	Buna-N	Viton®	Manifold (Viton®)
10M	SLKT-343	SLKT-343V	SLKT-241V
14M	SLKT-344	SLKT-344V	
20M	SLKT-345	SLKT-345V	SLKT-242V
28M	SLKT-346	SLKT-346V	SLKT-243V

Basic Unit Dimensions

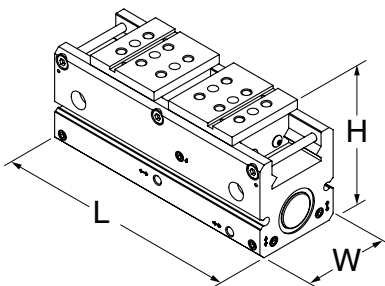

Size	L	W	H
10M-6	62.9 [2.48]	25 [0.98]	34.67 [1.36]
10M-12	73.7 [2.90]		42.21 [1.66]
14M-15	90.2 [3.55]	34 [1.34]	55.63 [2.19]
14M-25	118.7 [4.67]		72.54 [2.86]
20M-25	129 [5.08]	46 [1.81]	
20M-38	175.5 [6.91]		
28M-31	162.3 [6.39]	58 [2.28]	
28M-50	221.5 [8.72]		

RP-P SERIES

2-Jaw Precision Parallel Grippers

How To Order

CLICK OR SCAN
To view full
catalog pages
on this product

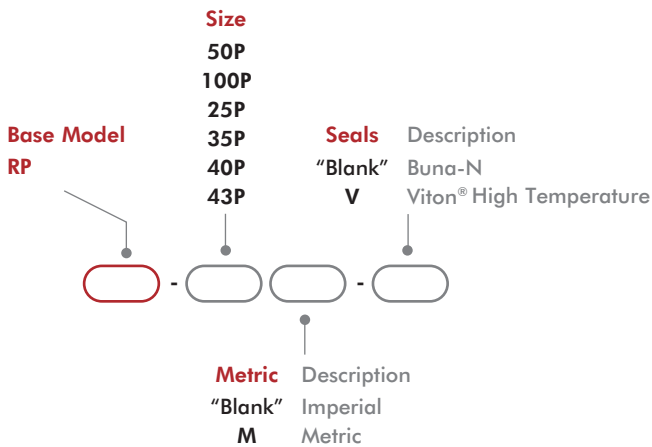

Size	Seal Repair Kits		Inductive Sensor Mtg Kit (mounts 2 sensors)
	Buna-N	Viton®	
50P	SLKT-353	SLKT-353V	OSMK-003
100P	SLKT-037	SLKT-037V	OSMK-004
25P	SLKT-046	SLKT-046V	OSMK-023
35P	SLKT-049	SLKT-049V	OSMK-023
40P	SLKT-050	SLKT-050V	OSMK-033
43P	SLKT-051	SLKT-051V	OSMK-033

Basic Unit Dimensions

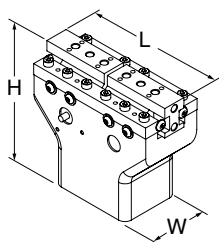

Size	L	W	H
50P	57 [2.24]	25.4 [1.00]	46.7 [1.84]
100P	83 [3.27]		59.4 [2.34]
25P	108 [4.25]	31.8 [1.25]	81.1 [3.19]
35P	143 [5.63]	50.8 [2.00]	103.2 [4.06]
40P	178 [7.01]	[2.25] 57.2	125 [4.92]
43P	292 [11.50]	74.7 [2.94]	175 [6.89]

RPL/RPLC SERIES

2-Jaw Precision Parallel Grippers

How To Order

CLICK OR SCAN
To view full
catalog pages
on this product



See page 5-8 for product availability in your region.

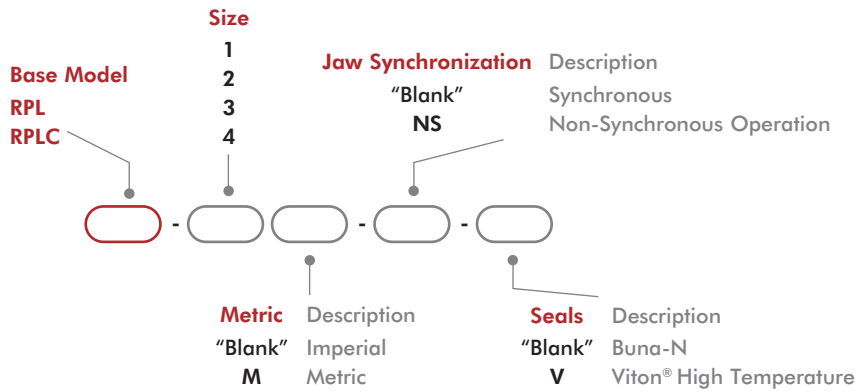

Size	Seal Repair Kits	
	Buna-N	Viton®
1		
2	SLKT-010	SLKT-010V
3		
4	SLKT-012	SLKT-012V

CP SERIES

2-Jaw General Industrial Grippers

How To Order

CLICK OR SCAN
To view full
catalog pages
on this product



See page 5-8 for product availability in your region.

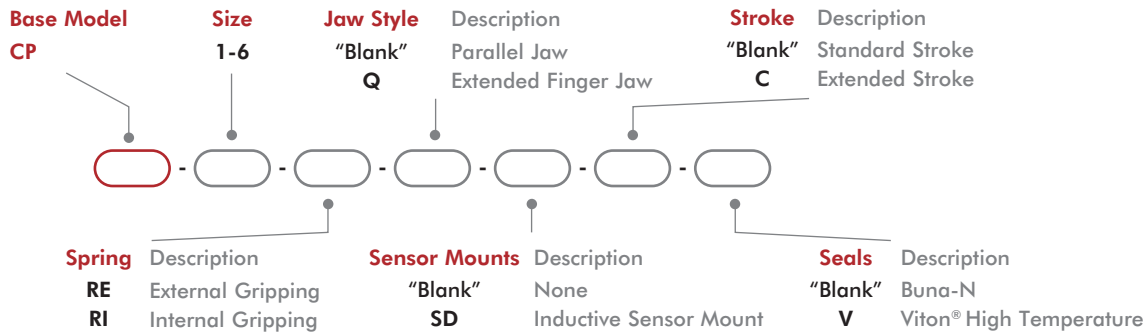
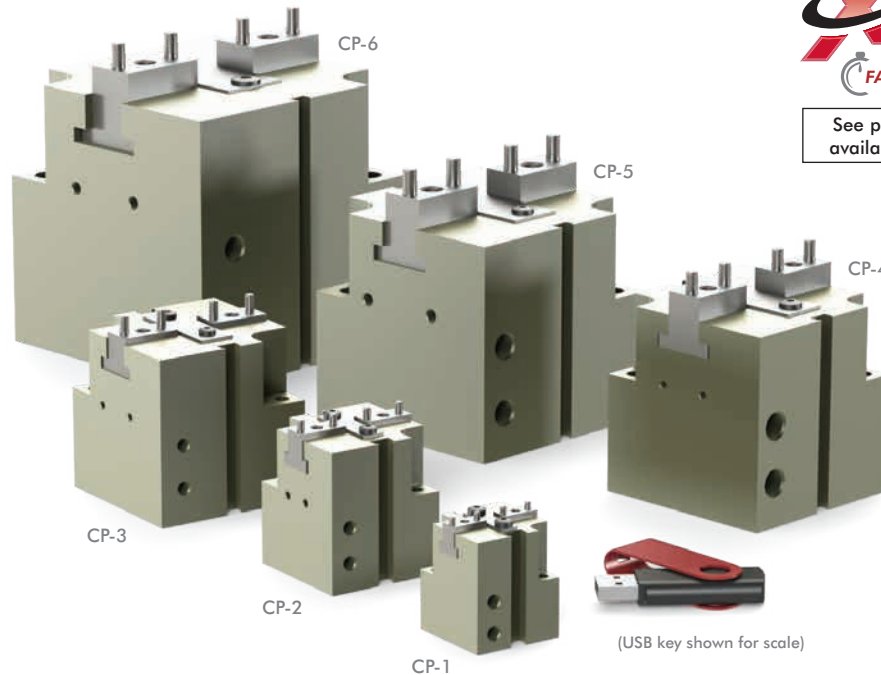

Size	Seal Repair Kits		Repair Kits (screws, springs, seals) -C		Inductive Sensor Mtg Kit (mounts 2 sensors) -SD
	Buna-N	Viton®	Buna-N	Viton®	
1	SCP1	SCP1V	KSCP1	KSCP1V	N/A
2	SCP2	SCP2V	KSCP2	KSCP2V	SDCP2
3	SCP3	SCP3V	KSCP3	KSCP3V	SDCP3
4	SCP4	SCP4V	KSCP4	KSCP4V	SDCP4
5	SCP5	SCP5V	KSCP5	KSCP5V	SDCP5
6	SCP1	SCP1V	KSCP1	KSCP1V	SDCP6

Basic Unit Dimensions

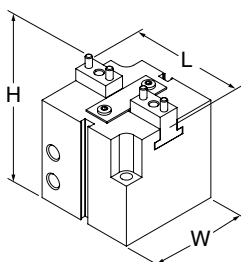

Size	L	L - C	W	H
1	37.6 [1.48]	42 [1.65]	30 [1.18]	39.2 [1.54]
2	51.4 [2.02]	58.2 [2.29]	40 [1.57]	51.5 [2.03]
3	70 [2.76]	81.2 [3.20]	55 [2.17]	67 [2.64]
4	85 [3.35]	96 [3.78]	65 [2.56]	74 [2.91]
5	102 [4.02]	120 [4.72]	80 [3.15]	91 [3.58]
6	125 [4.92]	141 [5.55]	100 [3.94]	114 [4.49]

DPDL SERIES

2-Jaw General Industrial Grippers

How To Order

CLICK OR SCAN
To view full
catalog pages
on this product

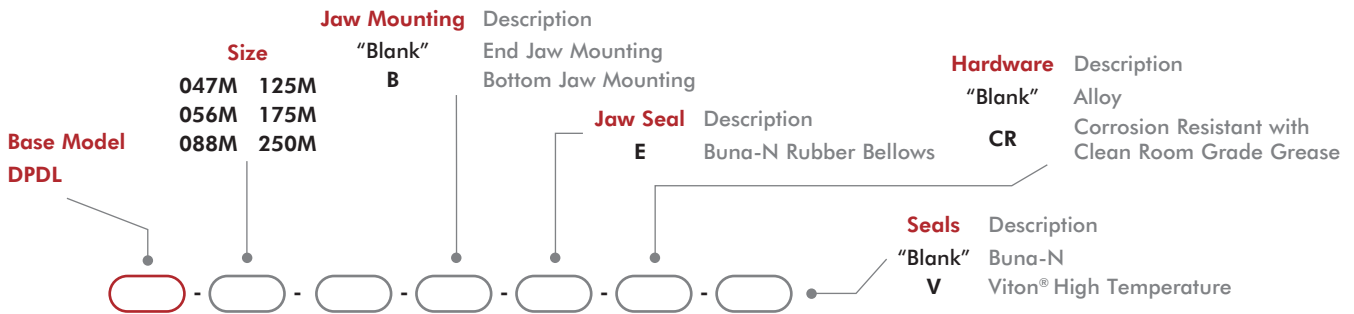
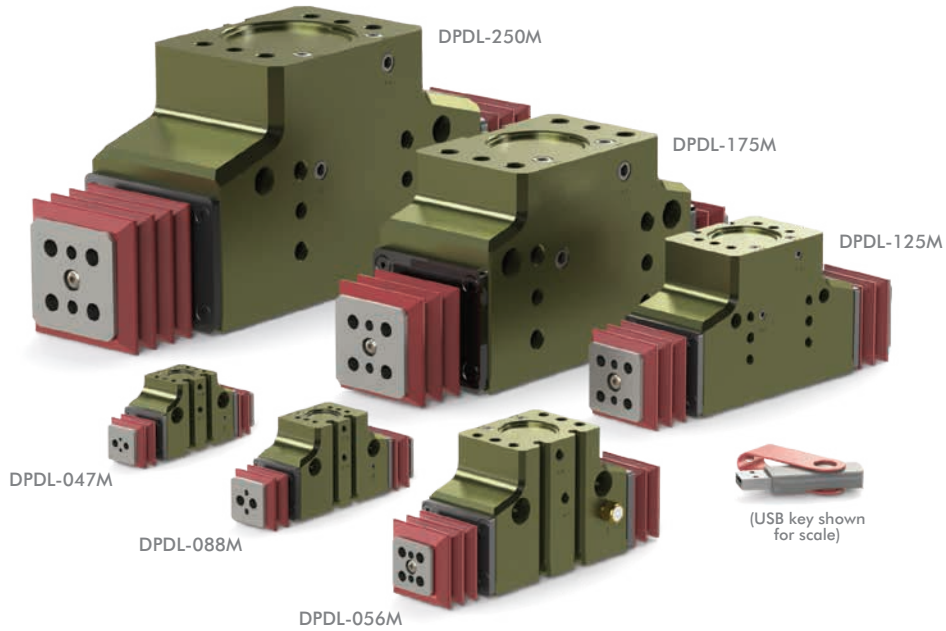

Stroke Stroke varies with size of gripper

047M	019, 025 or 038	125M	050, 075 or 100
056M	025, 038 or 050	175M	075, 100 or 150
088M	038, 050 or 075	250M	100, 150 or 200

Stroke dimensions

019	4.8mm [0.19]	050	12.7mm [0.50]	150	38.1mm [1.50]
025	6.4mm [0.25]	075	19.1mm [0.75]	200	50.8mm [2.00]
038	9.5mm [0.38]	100	25.4mm [1.00]		

Size	Seal Repair Kits			Sealed Jaw Boot Replacement (1 Buna-N Boot only)
	Buna-N	Viton®	Manifold (Viton®)	
047M	SLKT-185	SLKT-185V	SLKT-197V	SLKT-191
056M	SLKT-186	SLKT-186V		SLKT-192
088M	SLKT-187	SLKT-187V	SLKT-199V	SLKT-193
125M	SLKT-188	SLKT-188V		SLKT-194
175M	SLKT-189	SLKT-189V	SLKT-201V	SLKT-195
250M	SLKT-190	SLKT-190V		SLKT-196

Basic Unit Dimensions

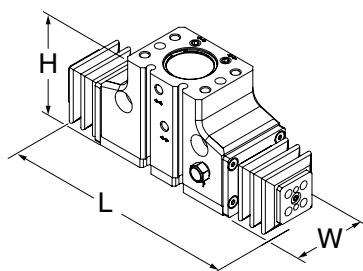

Size	L	W	H
047M	54.5 [2.16]	22.2 [.875]	32.2 [1.27]
056M	68.7 [2.70]	24.1 [.950]	37.7 [1.48]
088M	101.1 [3.98]	36.1 [1.420]	56 [2.20]
125M	128.4 [5.06]	43.2 [1.700]	68.5 [2.70]
175M	183.1 [7.21]	64.8 [2.550]	100.2 [3.94]
250M	243.8 [9.60]	79.3 [3.125]	123.3 [4.85]

DPDS SERIES

2-Jaw General Industrial Grippers

How To Order

CLICK OR SCAN
To view full
catalog pages
on this product

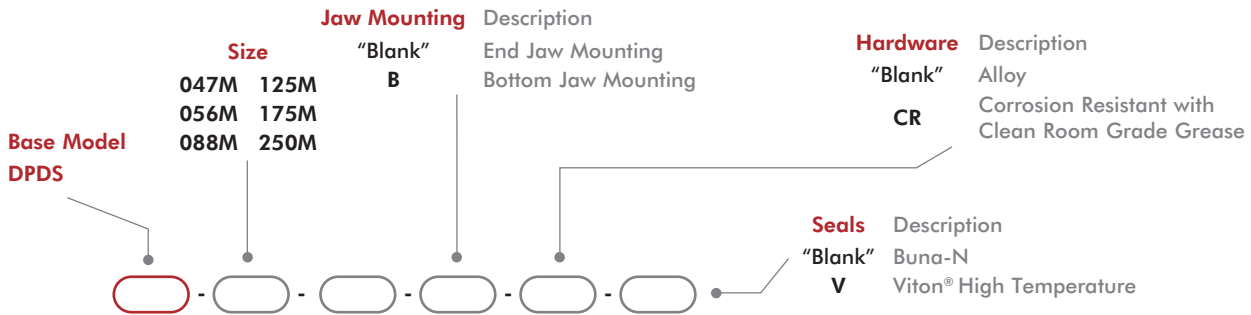
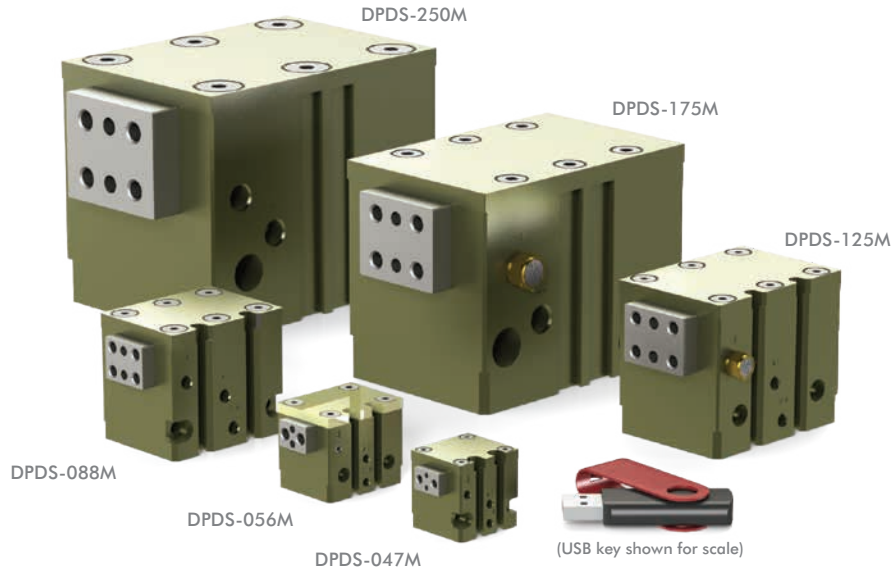

Stroke Stroke varies with size of gripper

047M	006, 009 or 013	125M	019, 025 or 038
056M	009, 013 or 019	175M	025, 038 or 050
088M	013, 019 or 025	250M	038, 050 or 075

Stroke dimensions

006	1.6mm [0.06]	019	4.8mm [0.19]	050	12.7mm [0.50]
009	2.4mm [0.09]	025	6.4mm [0.25]	075	19.1mm [0.75]
013	3.2mm [0.13]	038	9.5mm [0.38]		

Size	Specifications		
	Buna-N	Viton®	Manifold (Viton®)
047M	SLKT-185	SLKT-185V	SLKT-197V
056M	SLKT-186	SLKT-186V	
088M	SLKT-187	SLKT-187V	SLKT-199V
125M	SLKT-188	SLKT-188V	
175M	SLKT-189	SLKT-189V	SLKT-201V
250M	SLKT-190	SLKT-190V	

Basic Unit Dimensions

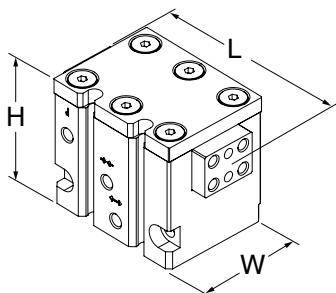

Size	L	W	H
047M	31.2 [1.23]	22.2 [0.87]	25.9 [1.02]
056M	39.8 [1.57]	24.1 [0.95]	28.9 [1.14]
088M	57.4 [2.26]	36.1 [1.42]	43.4 [1.71]
125M	73.5 [2.89]	43.2 [1.70]	52.7 [2.07]
175M	114.7 [4.52]	64.8 [2.55]	80.4 [3.17]
250M	133.1 [5.24]	79.3 [3.12]	95.5 [3.76]

RDH SERIES

2-Jaw General Industrial Grippers

How To Order

CLICK OR SCAN
To view full
catalog pages
on this product



See page 5-8 for product availability in your region.

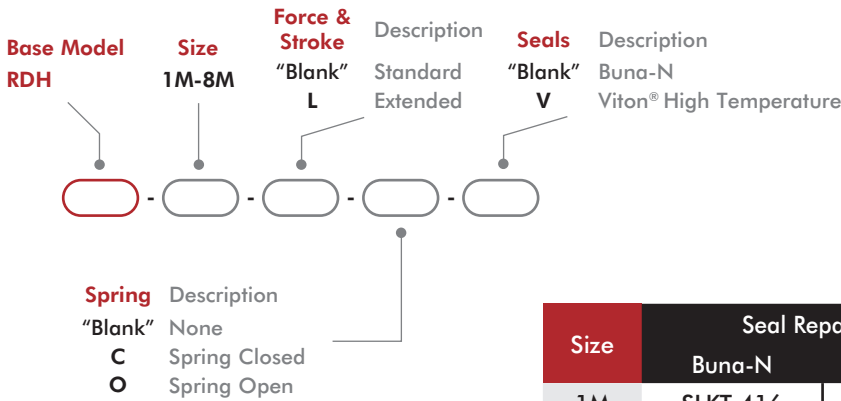
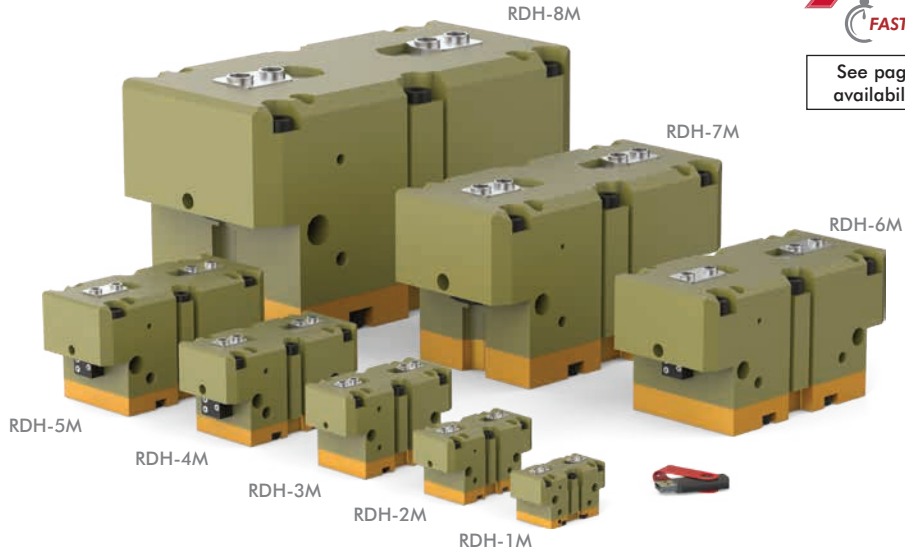

Size	Seal Repair Kits		Rear Inlet Seal Repair Kit	
	Buna-N	Viton®	Buna-N	Viton®
1M	SLKT-416	SLKT-416V	SLKT-363	SLKT-363V
2M	SLKT-417	SLKT-417V	SLKT-364	SLKT-364V
3M	SLKT-418	SLKT-418V	SLKT-365	SLKT-365V
4M	SLKT-419	SLKT-419V	SLKT-366	SLKT-366V
5M	SLKT-420	SLKT-420V		
6M	SLKT-421	SLKT-421V		
7M	SLKT-422	SLKT-422V		
8M	SLKT-423	SLKT-423V		

Basic Unit Dimensions

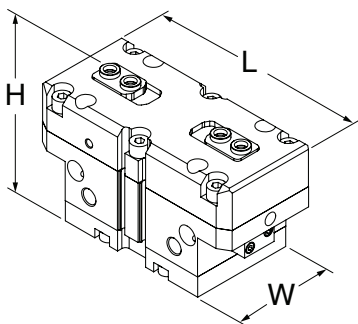

Size	L	W	H
1M	63 [2.48]	33 [1.30]	38.5 [1.52]
2M	83 [3.27]	40 [1.57]	58 [2.28]
3M	104 [4.09]	50 [1.97]	66 [2.60]
4M	129 [5.08]	60 [2.36]	74.5 [2.93]
5M	162 [6.38]	76 [2.99]	90.5 [3.56]
6M	205 [8.07]	100 [3.94]	113 [4.45]
7M	258 [10.16]	120 [4.72]	147 [5.79]
8M	355 [13.98]	180 [7.09]	201 [7.91]

REP2 SERIES

2-Jaw General Industrial Grippers

How To Order

CLICK OR SCAN
To view full
catalog pages
on this product



See page 5-8 for product availability in your region.



(USB key shown for scale)

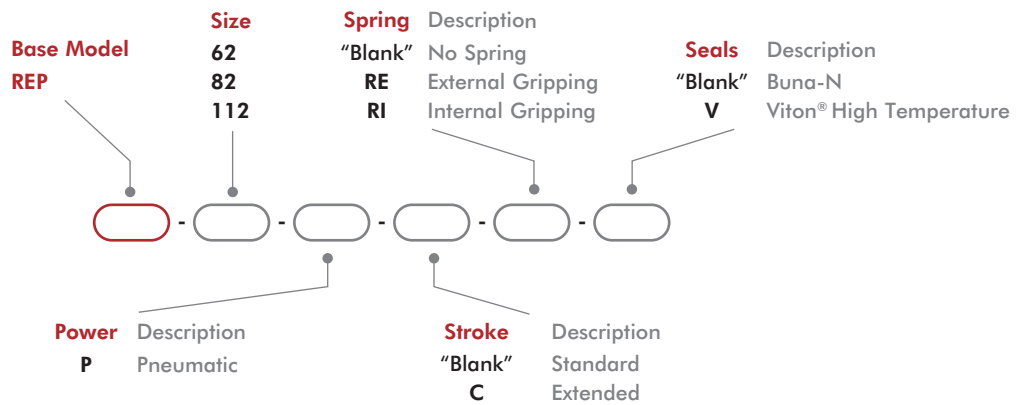

Size	Seal Repair Kits	
	Buna-N	Viton®
62P	SLKT-155	SLKT-155V
82P	SLKT-157	SLKT-157V
112P	SLKT-158	SLKT-158V

RP5-10 SERIES

2-Jaw General Industrial Grippers

How To Order

CLICK OR SCAN
To view full
catalog pages
on this product



See page 5-8 for product availability in your region.

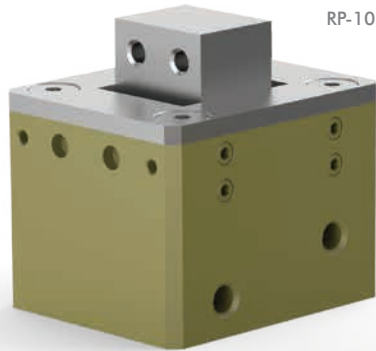

U.S. Patent #5,125,708



(USB key shown for scale)

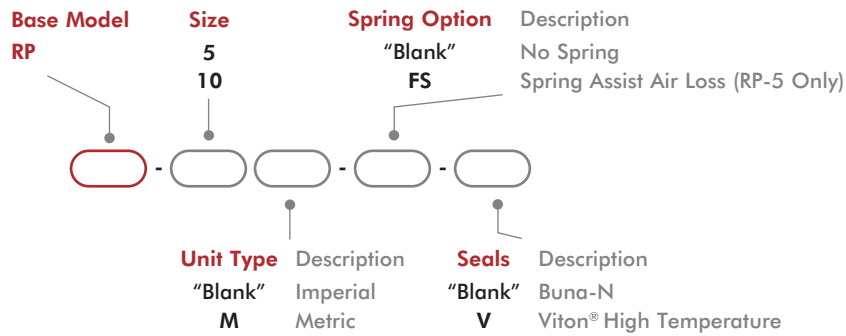

Size	Seal Repair Kits	
	Buna-N	Viton®
5	SLKT-152	SLKT-152V
10	SLKT-136	SLKT-136V

RP SERIES

2-Jaw General Industrial Grippers

How To Order

CLICK OR SCAN
To view full
catalog pages
on this product



See page 5-8 for product availability in your region.

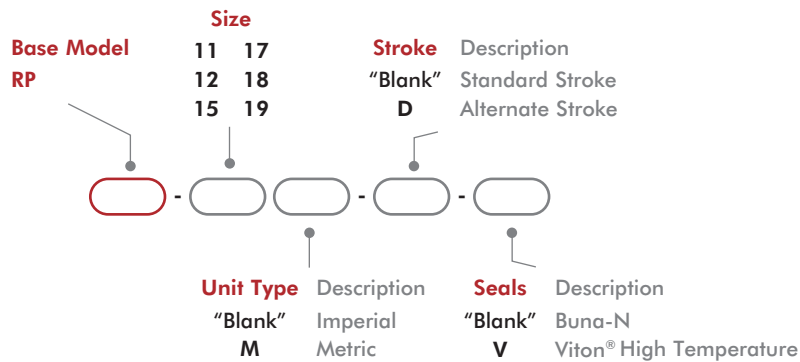
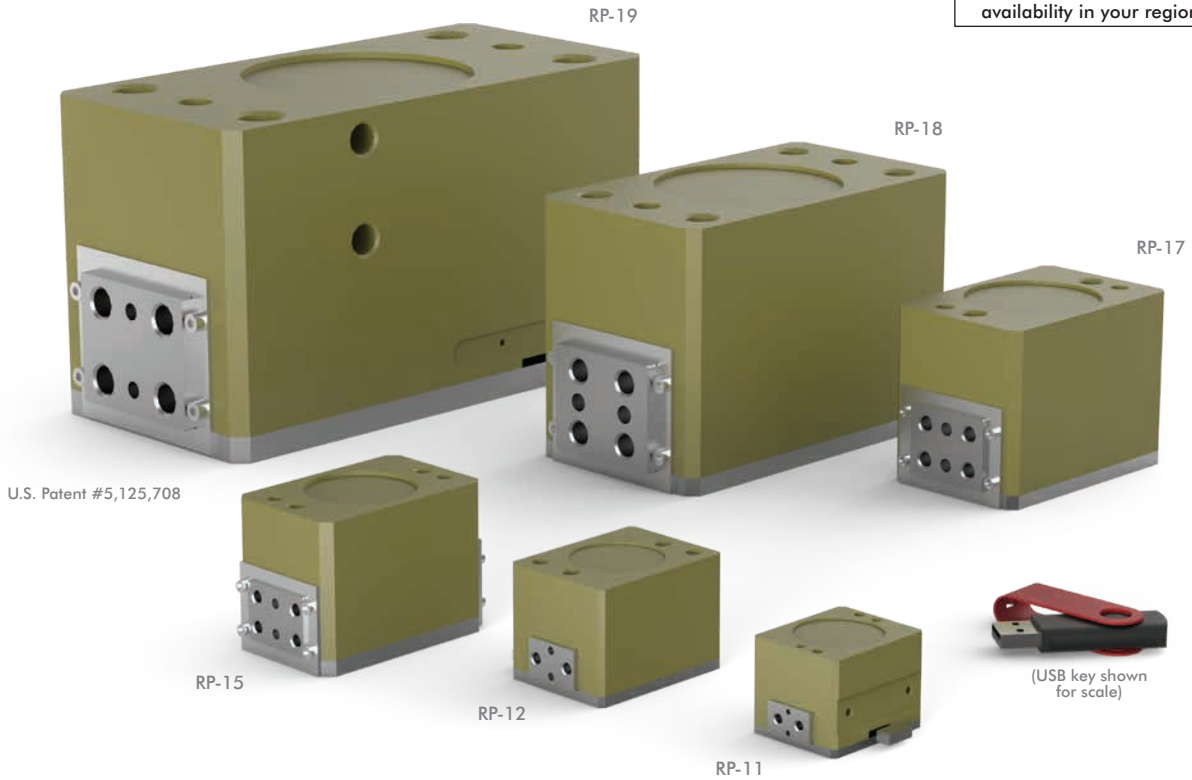

Size	Seal Repair Kits		Fail Safe Valve		Inductive Sensor Mtg Kit (mounts 2 sensors)
	Buna-N	Viton®	Imperial	Metric	
11	SLKT-036	SLKT-036V			
12	SLKT-040	SLKT-040V	OFSV-001	OFSV-004	OSMK-003
15	SLKT-041	SLKT-041V			
17	SLKT-042	SLKT-042V			
18	SLKT-043	SLKT-043V	OFSV-002	OFSV-005	OSMK-072
19	SLKT-044	SLKT-044V	OFSV-003	OFSV-006	OSMK-073

RPM/RPMC SERIES

2-Jaw General Industrial Grippers

How To Order

CLICK OR SCAN
To view full
catalog pages
on this product



See page 5-8 for product availability in your region.

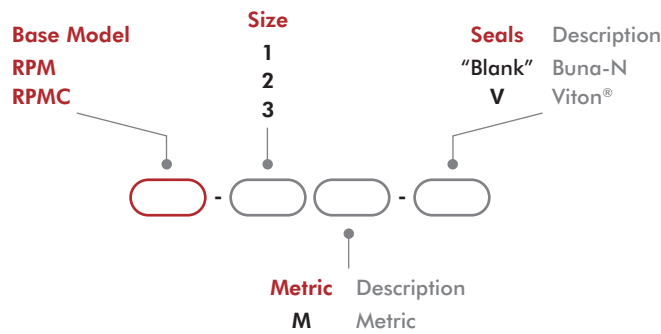
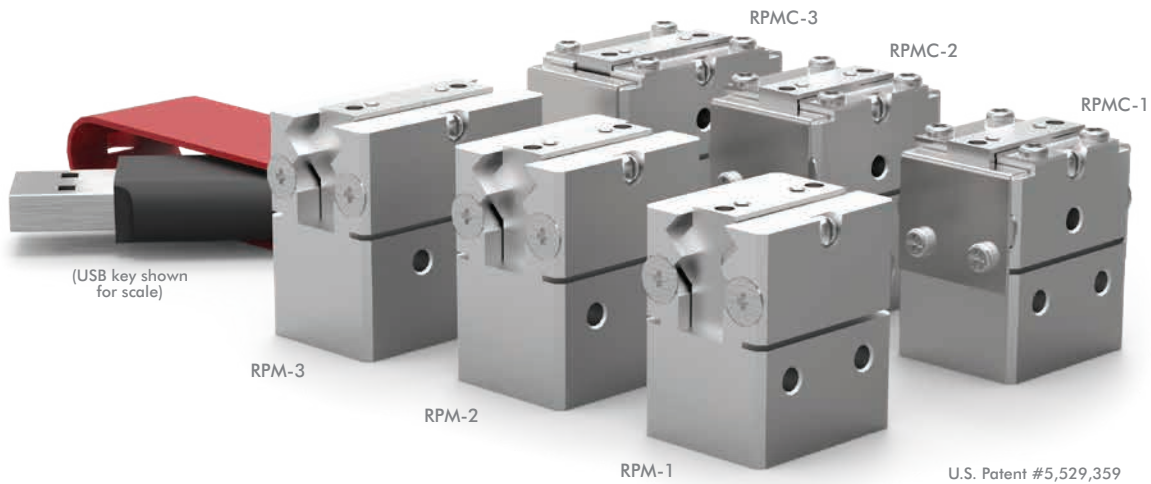

Basic Unit Dimensions

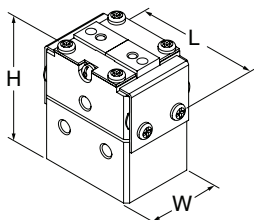

Size	L	W	H
1	23 [0.91]	16 [0.63]	24 [0.94]
2	24 [0.94]		25.5 [1.00]
3	30 [1.18]		

RPS SERIES

2-Jaw General Industrial Grippers

How To Order

CLICK OR SCAN
To view full
catalog pages
on this product

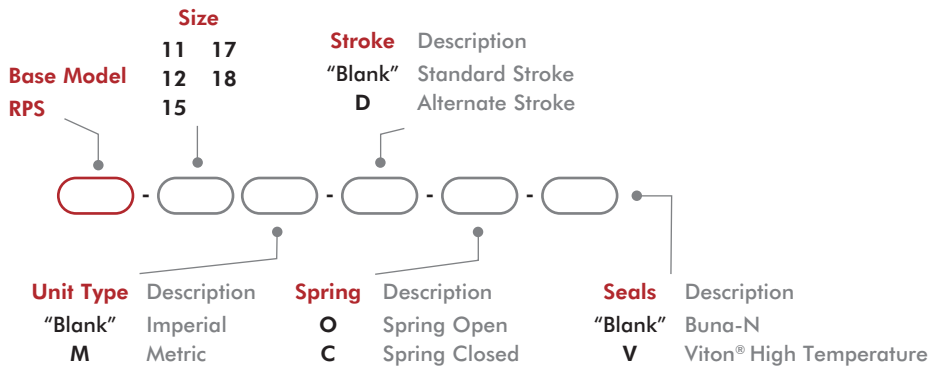

Size	Seal Repair Kits		Fail Safe Valve		Inductive Sensor Mtg Kit (mounts 2 sensors)
	Buna-N	Viton®	Imperial	Metric	
11	SLKT-036	SLKT-036V	OFSV-001	OFSV-004	OSMK-003
12	SLKT-040	SLKT-040V			
15	SLKT-041	SLKT-041V			
17	SLKT-042	SLKT-042V	OFSV-002	OFSV-005	OSMK-072
18	SLKT-043	SLKT-043V			

DPW SERIES

2-Jaw Heavy-Duty Parallel Grippers

How To Order

CLICK OR SCAN
To view full
catalog pages
on this product



See page 5-8 for product availability in your region.

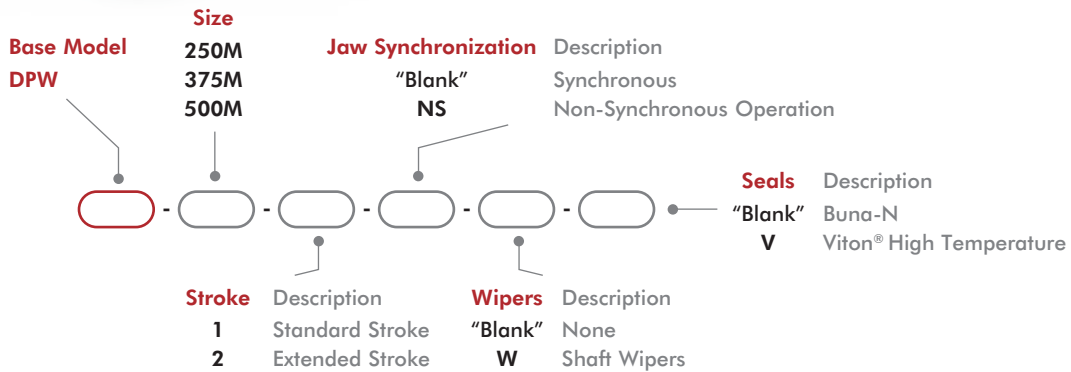
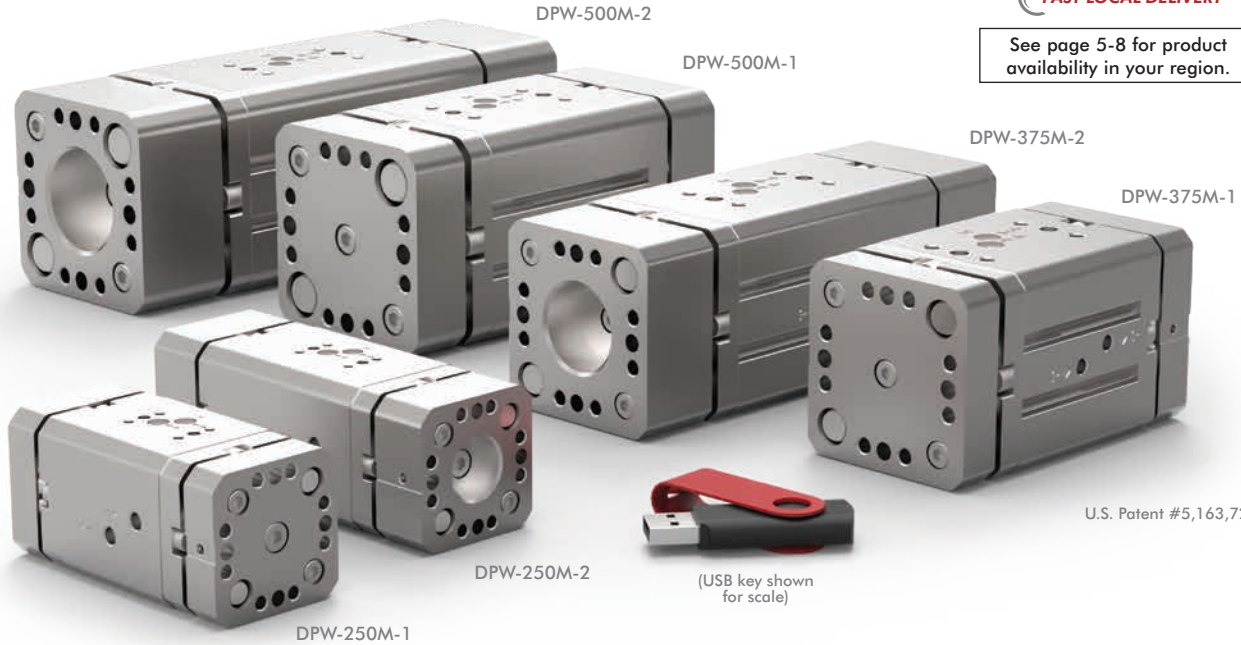

Size	Seal Repair Kits		Manifold Seal Kit Viton®	Shaft Wiper Seal Kit	Inductive Sensor Mtg Kit (3mm or 4mm)
	Buna-N	Viton®			
250M	SLKT-337	SLKT-337V	SLKT-197V	SLKT-338	OSMK-116
375M	SLKT-339	SLKT-339V	SLKT-199V	SLKT-340	OSMK-117
500M	SLKT-341	SLKT-341V		SLKT-342	OSMK-118

Basic Unit Dimensions

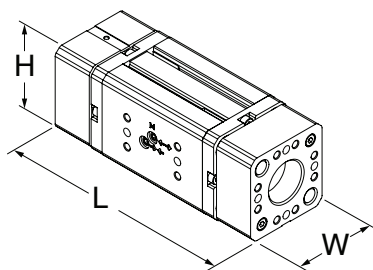

Size	L	W	H
250M-1	98 [3.86]	37.6 [1.48]	37.6 [1.48]
250M-2	136 [5.35]		
375M-1	122 [4.80]	54 [2.13]	54 [2.13]
375M-2	198 [7.80]		
500M-1	164 [6.46]	63 [2.48]	63 [2.48]
500M-2	240 [9.45]		

RPB SERIES

2-Jaw Heavy-Duty Parallel Grippers

How To Order

CLICK OR SCAN
To view full
catalog pages
on this product

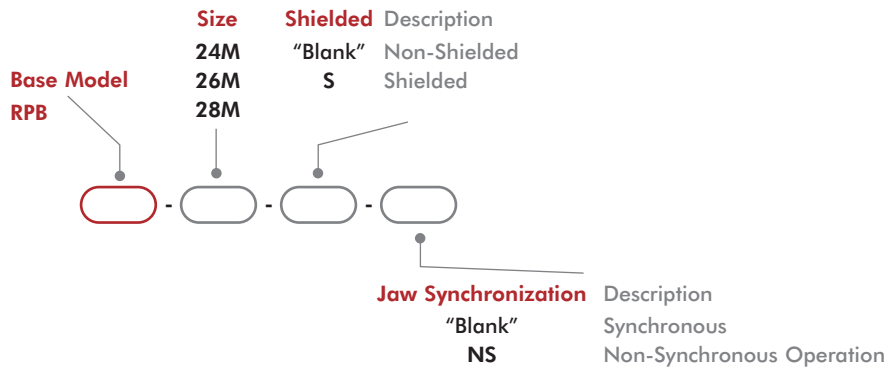

Size	Viton® Seal Repair Kits	Shield/Seal Repair Kit -S Only
24M		SLKT-152V
26M	SLKT-123V	SLKT-153V
28M		SLKT-166V

RPW SERIES

2-Jaw Heavy-Duty Parallel Grippers

How To Order

CLICK OR SCAN
To view full
catalog pages
on this product



See page 5-8 for product availability in your region.

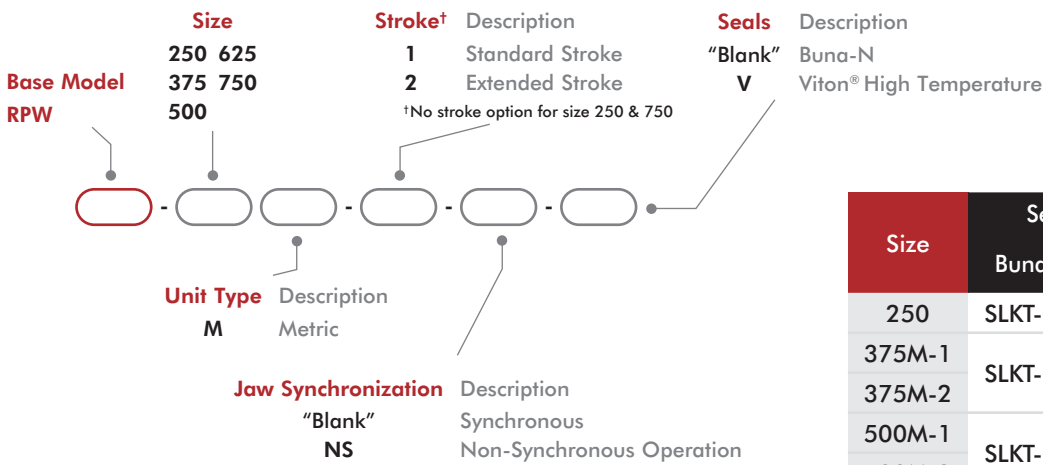

Size	Seal Repair Kits		Inductive Sensor Mtg Kit (2 Sensors)
	Buna-N	Viton®	
250	SLKT-055	SLKT-055V	OSMK-009
375M-1	SLKT-056	SLKT-056V	OSMK-010
375M-2			OSMK-011
500M-1	SLKT-058	SLKT-058V	OSMK-012
500M-2			OSMK-013
625M-1	SLKT-071	SLKT-071V	OSMK-074
625M-2			OSMK-014
750	SLKT-060	SLKT-060V	OSMK-014

Basic Unit Dimensions

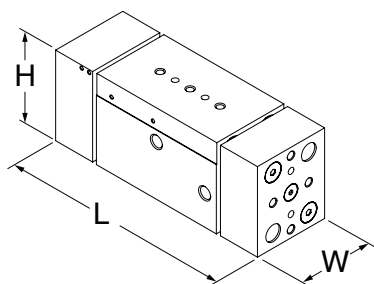

Size	L	W	H
250	93 [3.66]	31.5 [1.24]	40.9 [1.61]
375M-1	120 [4.72]	37.8 [1.49]	50.5 [1.99]
375M-2	187 [7.36]		
500M-1	171 [6.73]	56.9 [2.24]	66.4 [2.61]
500M-2	234 [9.21]		
625M-1	219 [8.62]	66.4 [2.61]	82.3 [3.24]
625M-2	321 [12.64]		
750	410 [16.14]	75 [2.95]	99.8 [3.93]

G100 SERIES

OEM Parallel Grippers

How To Order

CLICK OR SCAN
To view full
catalog pages
on this product



Base Model

Jaw Type

Jaw Type	Description
110	Horizontal Jaws
120	Extended Jaws*

Size

Size	Stroke	Description
08M	05, 10, 15, 20, 25	for Size 08
11M	05, 10, 15, 20, 25	for Size 11
18M	06, 12, 18, 24, 30	for Size 18
25M	10, 20, 30, 40, 50	for Size 25

Options

Options	Description
N	No Options

Seals

Seals	Description
B	Buna-N

G120 Extended Jaw Option Shown

Basic Unit Dimensions

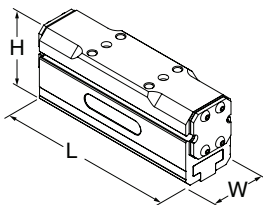

Size	L	W	H
G110-08M	43-103 [1.69-4.06]	20 [0.79]	28 [1.10]
G110-11M	43-103 [1.69-4.06]	24 [0.94]	36.5 [1.44]
G110-18M	54-125 [2.13-4.92]	30 [1.18]	43 [1.69]
G110-25M	73-193 [2.87-7.60]	40 [1.57]	61 [2.40]

3P SERIES

3-Jaw Parallel Grippers

How To Order

CLICK OR SCAN
To view full
catalog pages
on this product



See page 5-8 for product availability in your region.



Note: See catalog for complete options information.

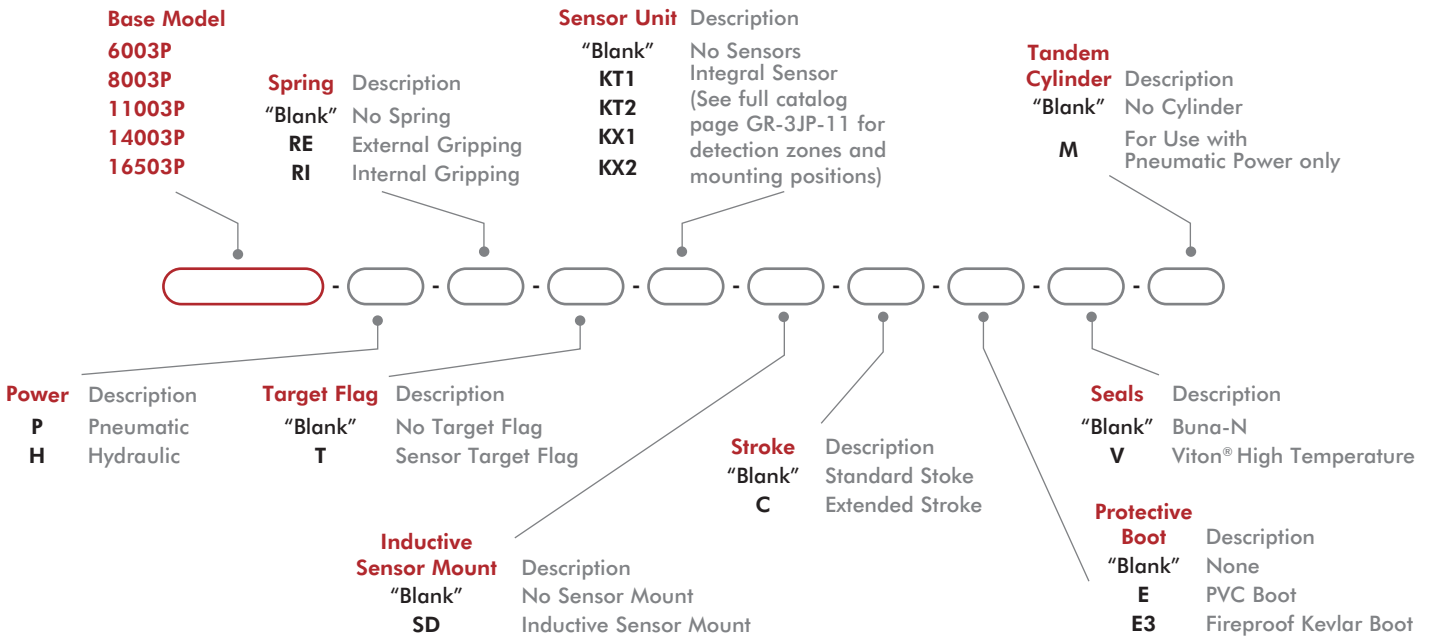

Size	Seal Repair Kits			Protective Boots	
	Buna-N	Viton®	Hydraulic	PVC - Brown or Black	Fireproof KEVLAR - Red
6003P	SLKT-156	SLKT-156V	SLKT-330	ER63P	E3R63P
8003P	S80	S80V	S80H	ER83P	E3R83P
11003P	S100	S110V	S110H	ER113P	E3R113P
14003P	SLKT-333	SLKT-333	SLKT-334	KP-317	KP-319
16503P	SLKT-335	SLKT-335V	SLKT-336	KP-320	KP-322

RTH SERIES

3-Jaw Parallel Grippers

How To Order

CLICK OR SCAN
To view full
catalog pages
on this product



See page 5-8 for product availability in your region.

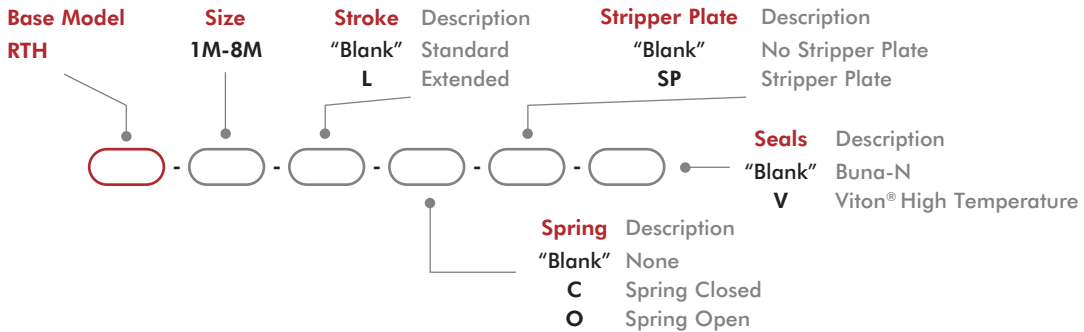
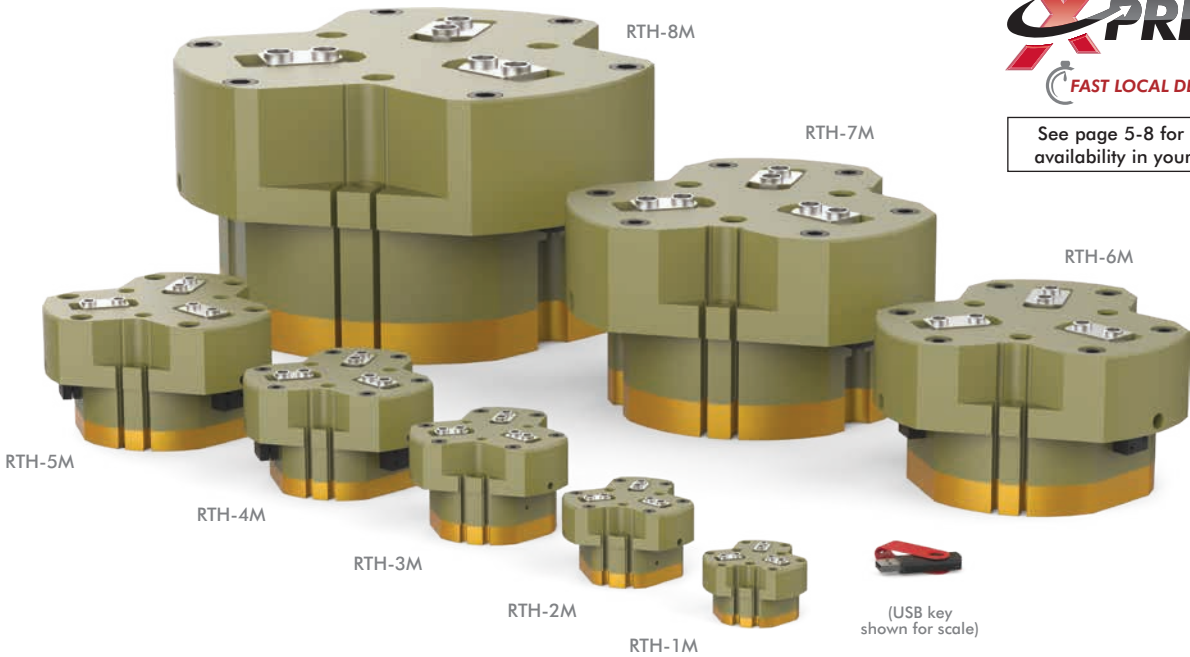

Size	Seal Repair Kits		Rear Inlet Seal Repair Kits	
	Buna-N	Viton®	Buna-N	Viton®
1M	SLKT-347	SLKT-347V	SLKT-363	SLKT-363V
2M	SLKT-348	SLKT-348V	SLKT-364	SLKT-364V
3M	SLKT-349	SLKT-349V	SLKT-365	SLKT-365V
4M	SLKT-350	SLKT-350V		

Size	Seal Repair Kits		Rear Inlet Seal Repair Kits	
	BunaN	Viton®	BunaN	Viton®
5M	SLKT351	SLKT351V		
6M	SLKT352	SLKT352V	SLKT365	SLKT365V
7M	SLKT353	SLKT353V		
8M	SLKT354	SLKT354V	SLKT366	SLKT366V

Basic Unit Dimensions

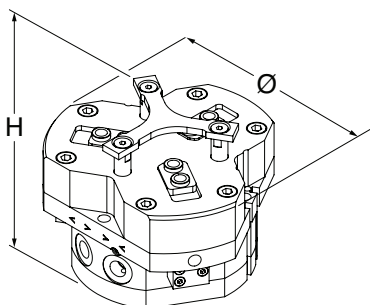

Size	Ø	H
1M	63 [2.48]	43 [1.69]
2M	83 [3.27]	57 [2.24]
3M	104 [4.09]	73.5 [2.89]
4M	129 [5.08]	88.5 [3.48]
5M	162 [6.38]	98.5 [3.88]
6M	205 [8.07]	121 [4.76]
7M	258 [10.16]	155 [6.10]
8M	355 [13.98]	209 [8.23]

PPC SERIES

3-Jaw Parallel Grippers

How To Order

CLICK OR SCAN
To view full
catalog pages
on this product



See page 5-8 for product availability in your region.

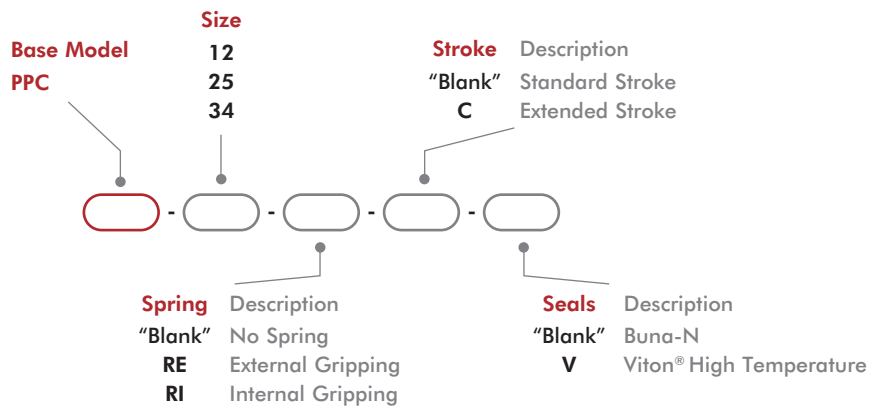

Basic Unit Dimensions

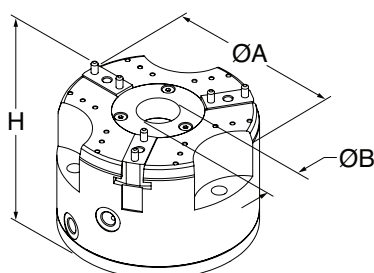

Size	Ø	H
12	43 [1.69]	74 [2.91]
12C	49.03 [1.93]	78 [3.07]
25	61.5 [2.42]	87 [3.43]
25C	68.5 [2.70]	92 [3.62]
34	82.5 [3.25]	112 [4.41]
34C	92.5 [3.64]	117 [4.61]

REP3 SERIES

3-Jaw Parallel Grippers

How To Order

CLICK OR SCAN
To view full
catalog pages
on this product



See page 5-8 for product
availability in your region.



(USB key shown
for scale)

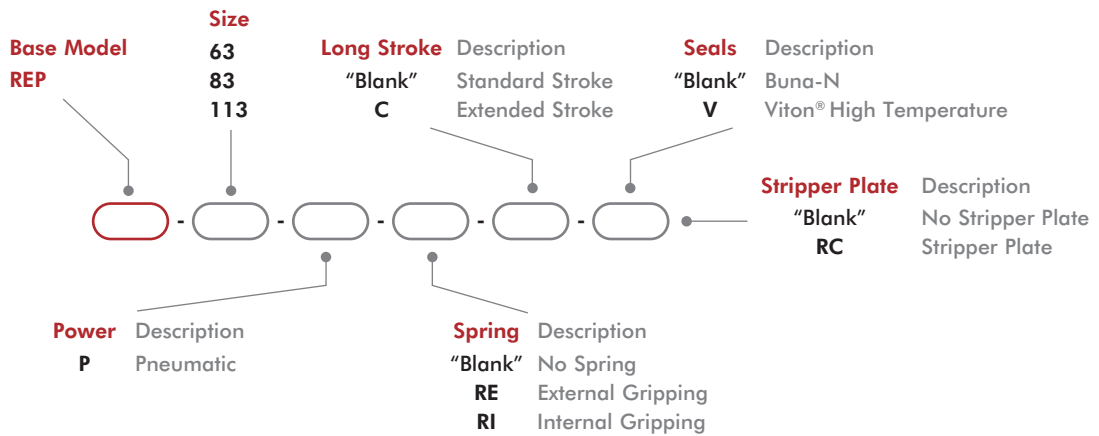

Size	Seal Repair Kits	
	Buna-N	Viton®
63P	SLKT-155	SLKT-155V
83P	SLKT-157	SLKT-157V
113P	SLKT-158	SLKT-158V

RPC SERIES

3-Jaw Parallel Grippers

How To Order

CLICK OR SCAN
To view full
catalog pages
on this product

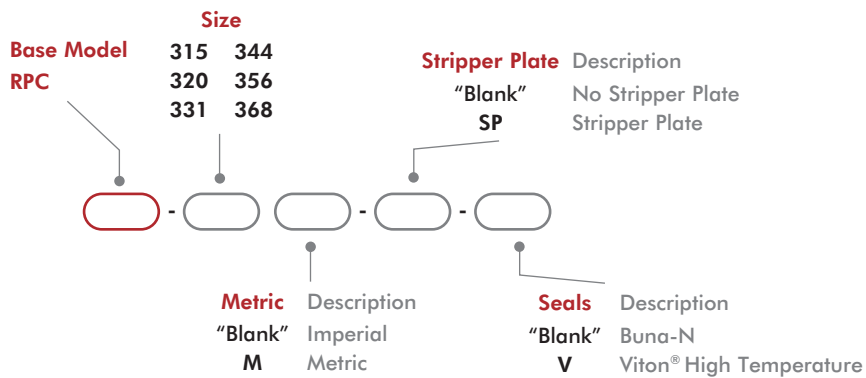

Basic Unit Dimensions

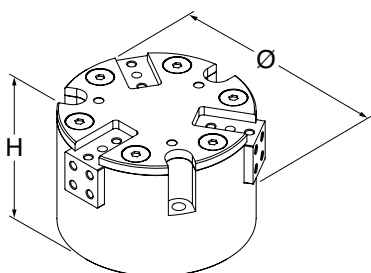

Size	Ø	H
315	62 [2.44]	41 [1.61]
320	82 [3.23]	50 [1.97]
331	118 [4.65]	75.1 [2.96]
344	140 [5.51]	82.2 [3.24]
356	184 [7.24]	101.1 [3.98]
368	206 [8.11]	118 [4.65]

CT/DCT & CT-RE/DCT-RE SERIES

Angular Grippers

How To Order

CLICK OR SCAN

To view full catalog pages on this product



See page 5-8 for product availability in your region.

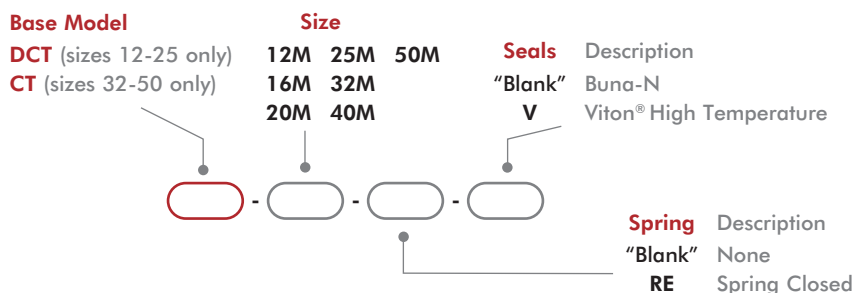
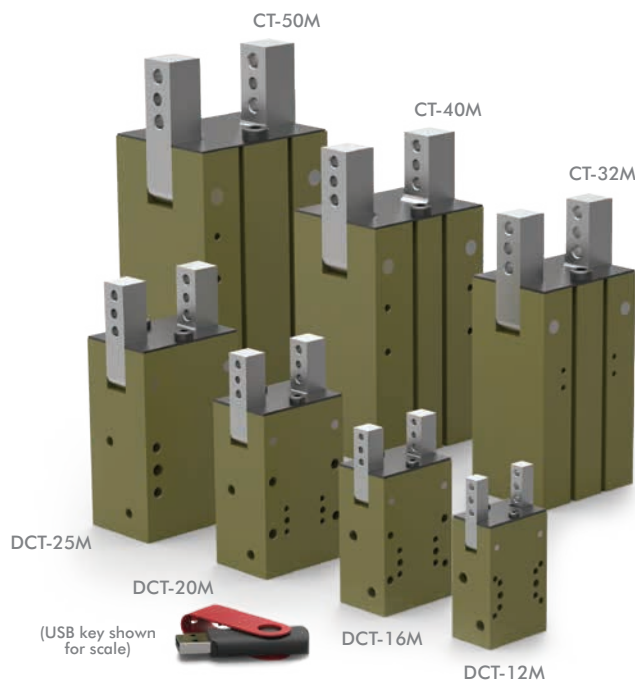

Size	Seal Repair Kits		Adjustment Stop Kit (1 shielded plate, 1 stop)	Inductive Sensor Mounting Kit (mounts 2 sensors)
	Buna-N	Viton®		
12M/12M-RE	SLKT-159	SLKT-159V	KP-DCT12-BR	N/A
16M/16M-RE	SLKT-160	SLKT-160V	KP-DCT16-BR	SDCT-16-20
20M/20M-RE	SLKT-161	SLKT-161V	KP-DCT20-BR	
25M/25M-RE	SLKT-162	SLKT-162V	KP-DCT25-BR	SDCT-25-32
32M/32M-RE	SLKT-163	SLKT-163V	KP-CT32-BR	
40M/40M-RE	SLKT-164	SLKT-164V	KP-CT40-BR	SDCT-40-63
50M/50M-RE	SLKT-165	SLKT-165V	KP-CT50-BR	

Basic Unit Dimensions

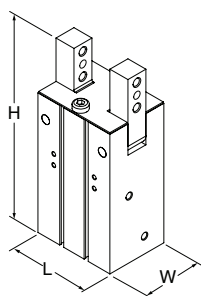

Size	L	W	H -CT	H -CT-RE
12M	30 [1.18]	20 [0.79]	48 [1.89]	64 [2.52]
16M	36 [1.42]	25 [0.98]	64 [2.52]	71 [2.80]
20M	42 [1.65]	30 [1.18]	79 [3.11]	83 [3.27]
25M	50 [1.97]	36 [1.42]	93.5 [3.68]	102 [4.02]
32M	56 [2.20]	42 [1.65]	95 [3.74]	116 [4.57]
40M	66 [2.60]	52 [2.05]	107.5 [4.23]	135 [5.31]
50M	76 [2.99]	62 [2.44]	146 [5.75]	163 [6.42]

RA (TOGGLE LOCK) SERIES

Angular Grippers

How To Order

CLICK OR SCAN
To view full
catalog pages
on this product



See page 5-8 for product availability in your region.

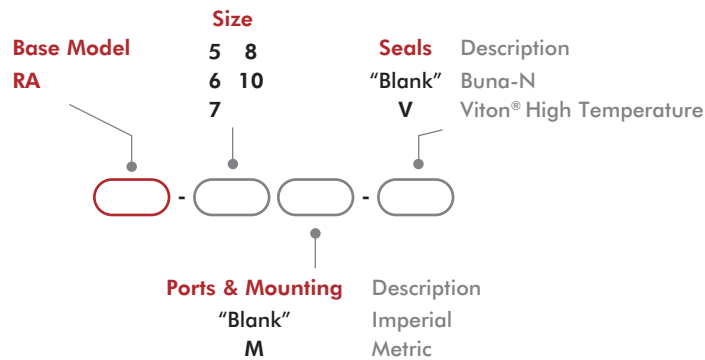
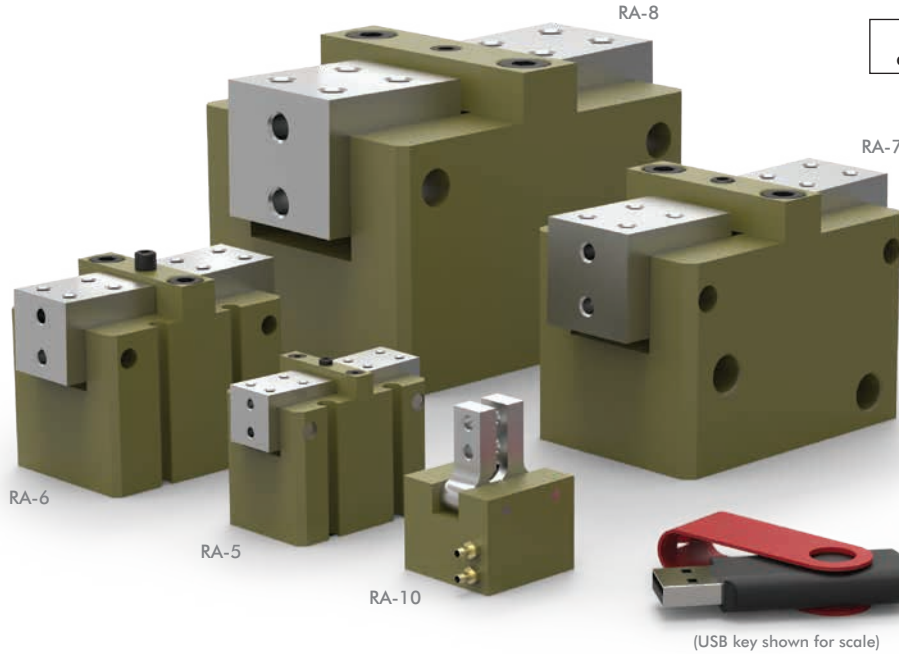

Size	Seal Repair Kits	
	Buna-N	Viton®
5	SLKT-022	SLKT-022V
6	SLKT-023	SLKT-023V
7	SLKT-118	SLKT-118V
8	SLKT-119	SLKT-119V
10	SLKT-018	SLKT-018V

Basic Unit Dimensions

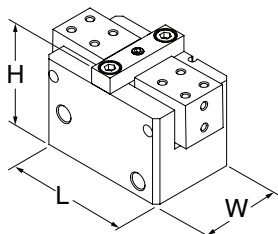

Size	L	W	H
5	25.4 [1.00]	38.1 [1.50]	35.0 [1.38]
6	38.1 [1.50]	50.8 [2.00]	49.6 [1.95]
7	50.8 [2.00]	76.2 [3.00]	60.8 [2.39]
8	76.2 [3.00]	101.6 [4.00]	76.2 [3.00]
10	25.4 [1.00]	25.4 [1.00]	20.7 [0.81]

RA (TOGGLE LOCK) SERIES

Angular Grippers

How To Order

CLICK OR SCAN
To view full
catalog pages
on this product



(USB key shown for scale)

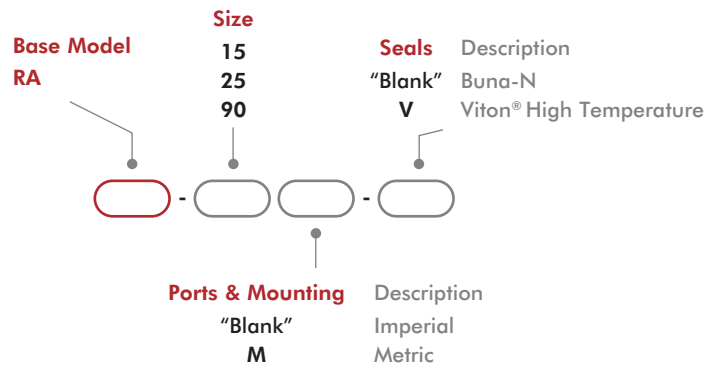

Size	Inductive Sensor Mounting Kit (mounts 2 sensors)	Seal Repair Kits	
		Buna-N	Viton®
15	OSMK-018	SLKT-019	SLKT-019V
25	OSMK-019	SLKT-020	SLKT-020V
90	OSMK-003	SLKT-024	SLKT-024V

RUA SERIES

Angular Grippers

How To Order

CLICK OR SCAN
To view full
catalog pages
on this product



See page 5-8 for product availability in your region.

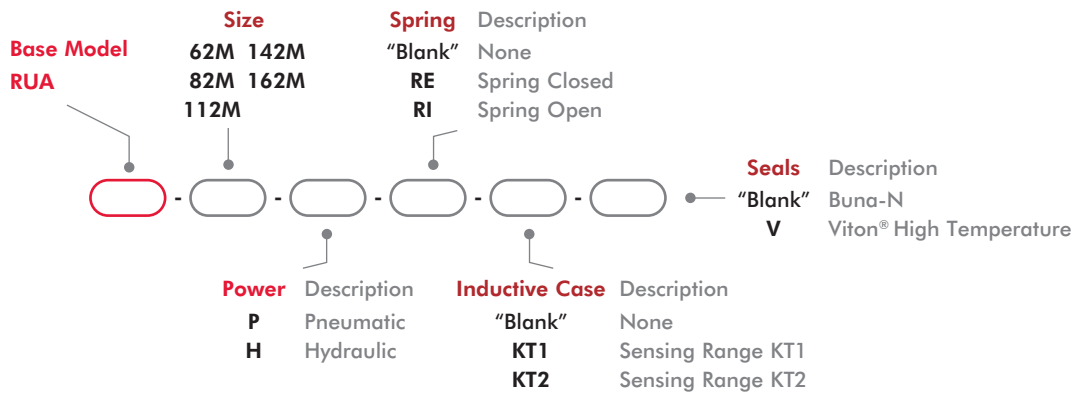

Size	Seal Repair Kits Buna-N Standard	Seal Repair Kits Viton®	Sealed Boots (2 interfaces, 1 collar, 1 boot)	
			PVC	Kevlar
62M	OSMK-156	OSMK-156V	SLKT-367	SLKT-368
82M	OSMK-157	OSMK-157V	SLKT-370	SLKT-371
112M	OSMK-158	OSMK-158V	SLKT-373	--
142M	OSMK-333	OSMK-333V	SLKT-376	--
162M	OSMK-335	OSMK-335V	SLKT-379	--

FUA SERIES

Angular Grippers

How To Order

CLICK OR SCAN
To view full
catalog pages
on this product



See page 5-8 for product availability in your region.



Base Model
FUA-50M
FUA-63M



Spring Description
"Blank" None
C Spring Closed

Technical Data

Specifications	Units	FUA-50M	FUA-63M
Torque, Jaws @ 0° (mid-stroke)			
@ 6 bar [87 psi], w/spring	Nm [in-lbs]	13 [115]	32 [283]
@ 0 bar [0 psi], w/spring	Nm [in-lbs]	16 [142]	9 [80]
Total Stroke		14 [124]	70°
Weight (Stainless Steel)	kg [lbs]	70°	1.7 [3.75]
Weight (Polymer)	kg [lbs]	1,06 [2.34]	0.8 [1.76]
Pressure Range without springs	bar [psi]	3-7 [44-100]	2-7 [30-100]
Pressure Range with springs	bar [psi]	IP69K	3.5-7 [50-100]
Ingress Protection Class (IP)		30,2 [1.84]	IP69K
Displacement	cm ³ [in ³]	-15°~80° [5°~175°]	54 [3.30]
Temperature Range	°C [°F]	0.07 / 0.07	-15°~80° [5°~175°]

Basic Unit Dimensions

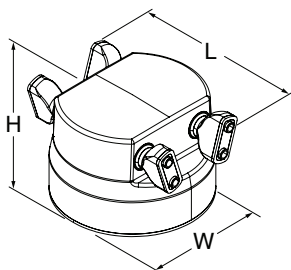

Size	L	W	H
FUA-50	85 [3.35]	75 [2.95]	52 [2.05]
FUA-63	100 [3.94]	90 [3.54]	62 [2.44]

RR LIGHT-DUTY SERIES

Rotary Actuators

How To Order

CLICK OR SCAN
To view full
catalog pages
on this product



See page 5-8 for product availability in your region.



(USB key shown for scale)

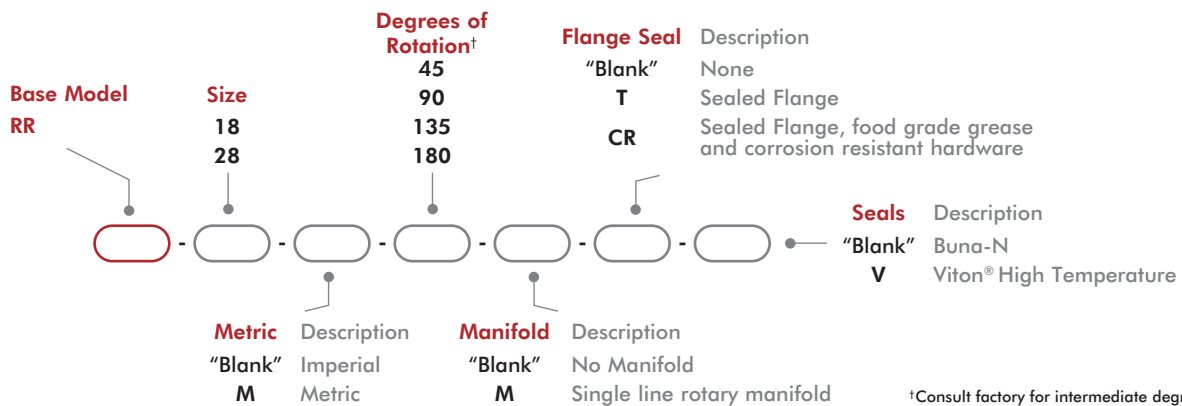

Size	Base Unit Seal Repair Kits Buna-N	Seal Repair Kits Viton®	Bottom Air Port Manifold Seal Kit - Viton®
18	SLKT-173	SLKT-173V	SLKT-174V
28	SLKT-175	SLKT-175V	SLKT-176V

Basic Unit Dimensions

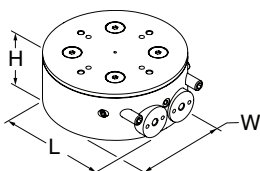

Size	L	W	H
18	170.9 [6.73]	101.6 [4.00]	43.7 [1.72]
28	203.2 [8.00]	113.5 [4.47]	54.1 [2.13]

RR MEDIUM-DUTY SERIES

Rotary Actuators

How To Order

CLICK OR SCAN
To view full
catalog pages
on this product



See page 5-8 for product availability in your region.

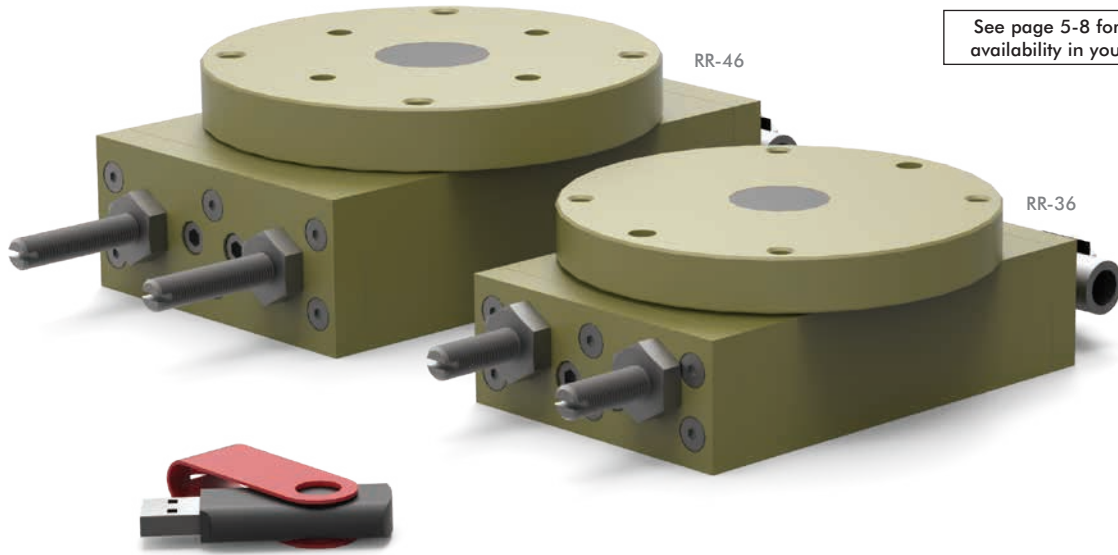

(USB key shown for scale)

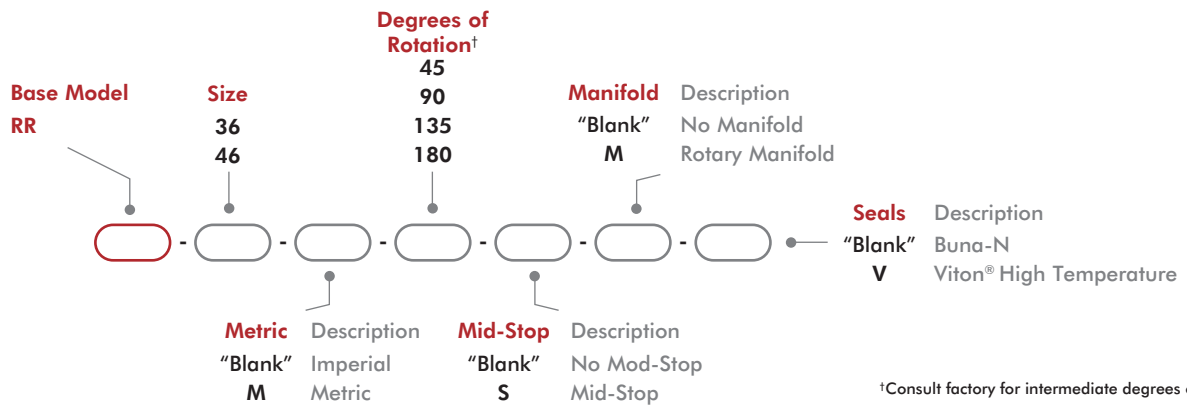

Size	Base Unit Seal Repair Kits		Manifold Seal Repair Kits		Mid-Stop Seal Repair Kits	
	Buna-N	Viton®	-M Buna-N	-M-V Viton®	-S Buna-N	-S-V Viton®
36	SLKT-016	SLKT-016V	SLKT-061	SLKT-061V	SLKT-062	SLKT-062V
46	SLKT-017	SLKT-017V	SLKT-067	SLKT-067V	SLKT-068	SLKT-068V

Basic Unit Dimensions

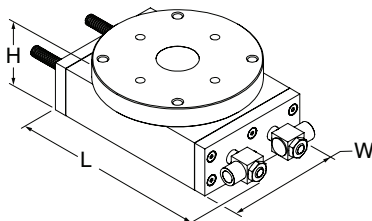

Size	L	W	H
36	170.9 [6.73]	101.6 [4.00]	43.7 [1.72]
46	203.2 [8.00]	113.5 [4.47]	54.1 [2.13]

RR HEAVY-DUTY SERIES

Rotary Actuators

How To Order

CLICK OR SCAN
To view full
catalog pages
on this product



See page 5-8 for product availability in your region.

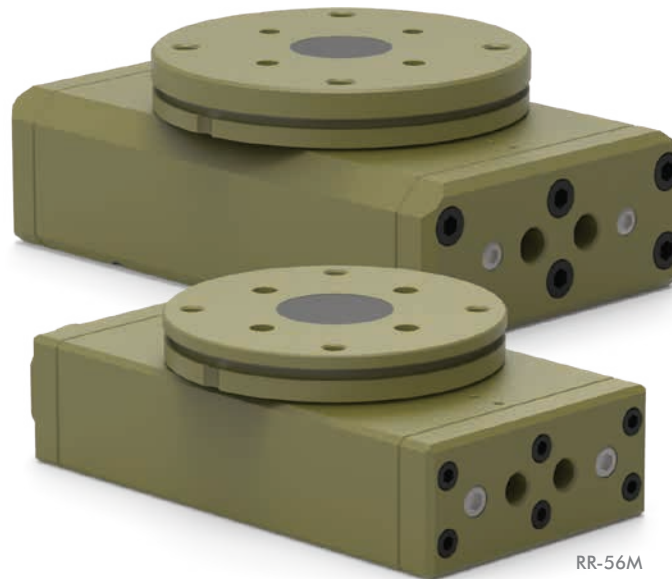

RR-66M

RR-56M

(USB key shown for scale)

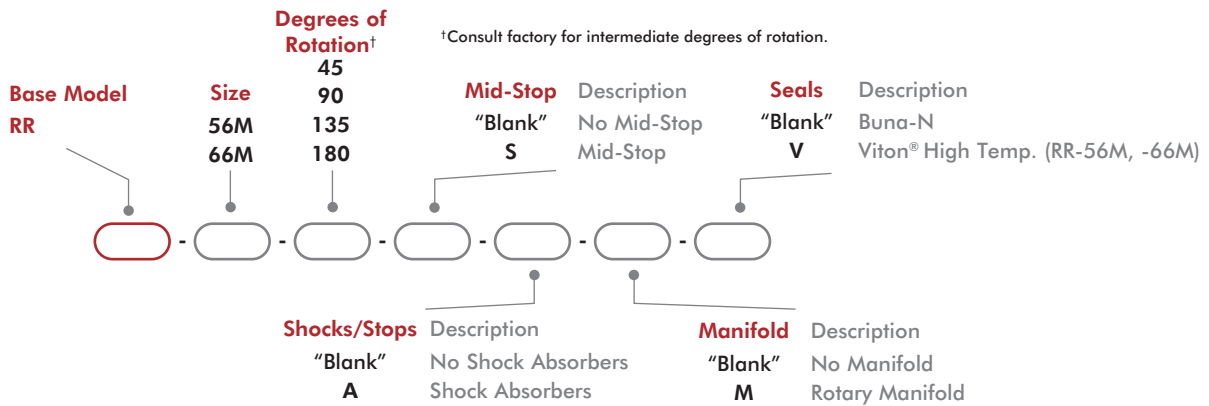

Size	Base Unit Seal Repair Kits		Manifold Seal Repair Kits		Mid-Stop Seal Repair Kits		Shock Seal Repair Kits	
	Buna-N	Viton®	-M Buna-N	-M-V Viton®	-S Buna-N	-S-V Viton®	-A Buna-N	-A-V Viton®
56	SLKT-124	SLKT-124V	SLKT-126	SLKT-126V	SLKT-127	SLKT-127V	SLKT-125	SLKT-125V
66	SLKT-128	SLKT-128V	SLKT-130	SLKT-130V	SLKT-131	SLKT-131V	SLKT-129	SLKT-129V

Basic Unit Dimensions

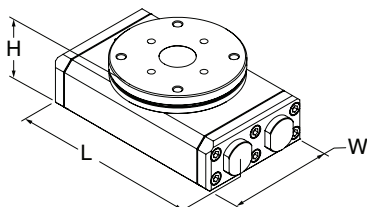

Size	L	W	H
56	[8.50] 215.9	117.5 [4.63]	70.2 [2.77]
66	[10.35] 262.8	158.8 [6.25]	96.8 [3.81]

DLB SERIES - INTERNAL AIR CYLINDER

Internal Air Cylinder Linear Base Slides

How To Order

CLICK OR SCAN
To view full
catalog pages
on this product

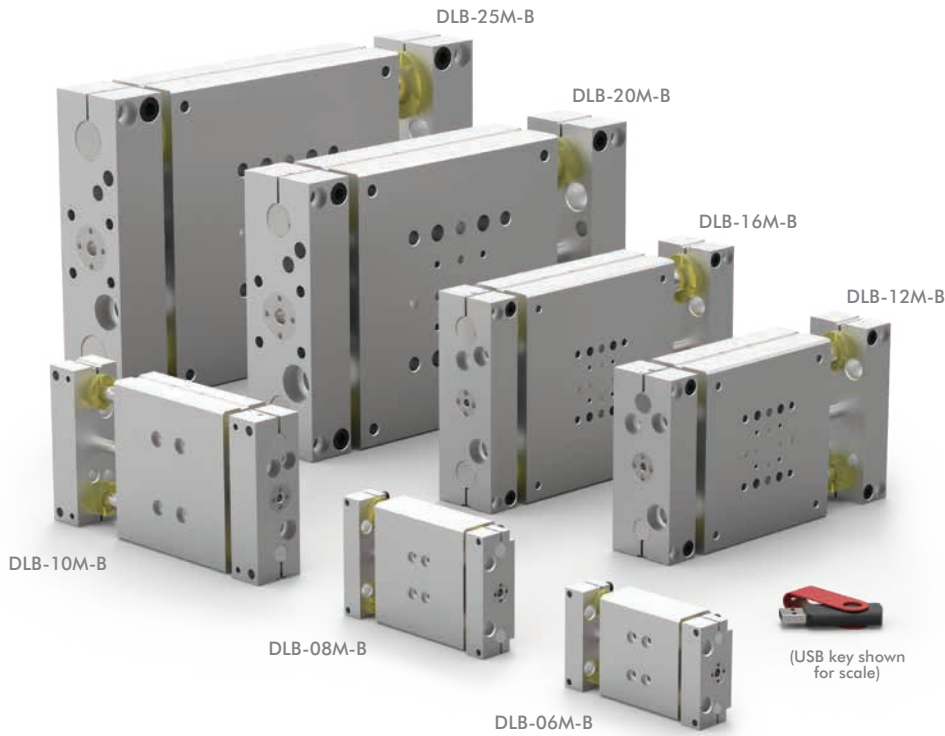

DLB-B series shown above

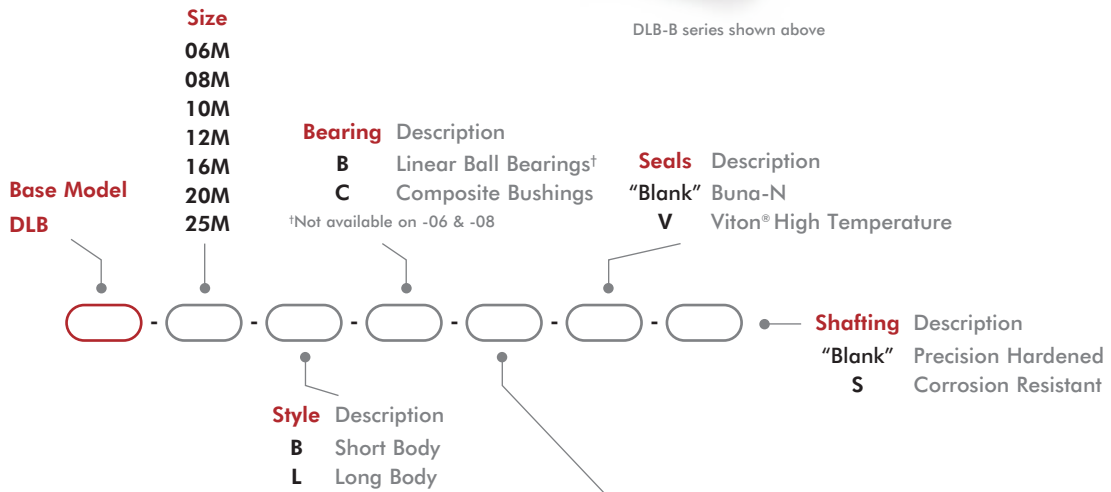

-B Style	Stroke* Metric (mm)
DLB-06M-B	6, 12, 25, 30
DLB-08M-B	6, 12, 25, 40, 44
DLB-10M-B	25, 50
DLB-12M-B	25, 50
DLB-16M-B	25, 50, 80
DLB-20M-B	25, 50, 80, 100
DLB-25M-B	25, 50, 80, 100, 125

-L Style	Stroke* Metric (mm)
DLB-06M-L	12, 25, 40, 50, 65, 75
DLB-08M-L	12, 25, 40, 50, 65, 75, 85
DLB-10M-L	25, 50, 80, 100
DLB-12M-L	25, 50, 80, 100, 125
DLB-16M-L	25, 50, 80, 100, 125, 150
DLB-20M-L	25, 50, 80, 100, 125, 160
DLB-25M-L	25, 50, 80, 100, 125, 160, 175

*Custom strokes available. Consult factory.

*Custom strokes available. Consult factory.



CLICK OR SCAN
To view full
catalog pages
on this product

DLB SERIES - EXTERNAL AIR CYLINDER

External Air Cylinder Linear Base Slides

How To Order

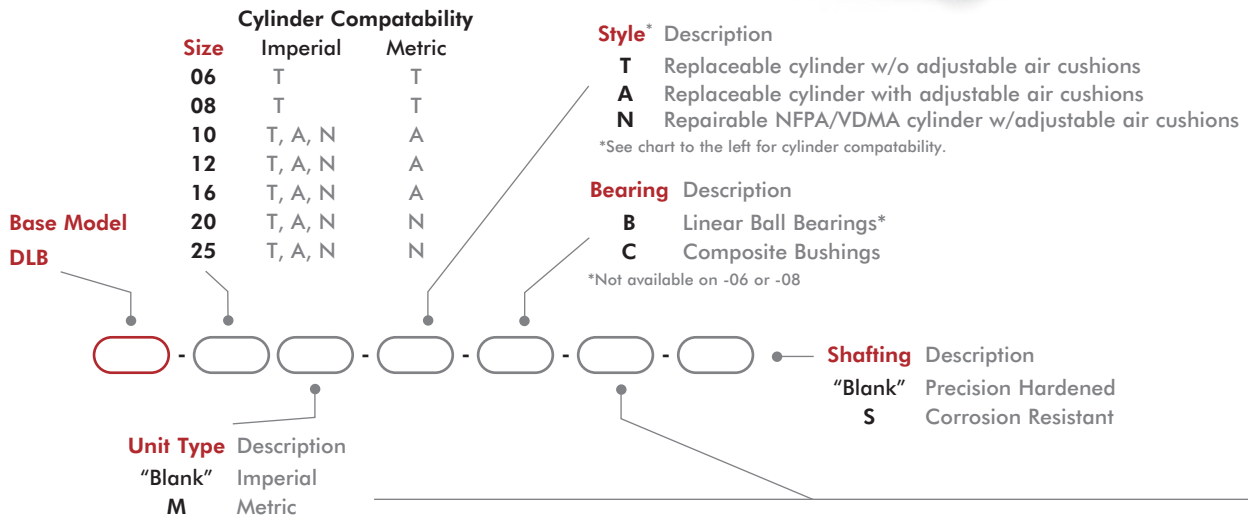
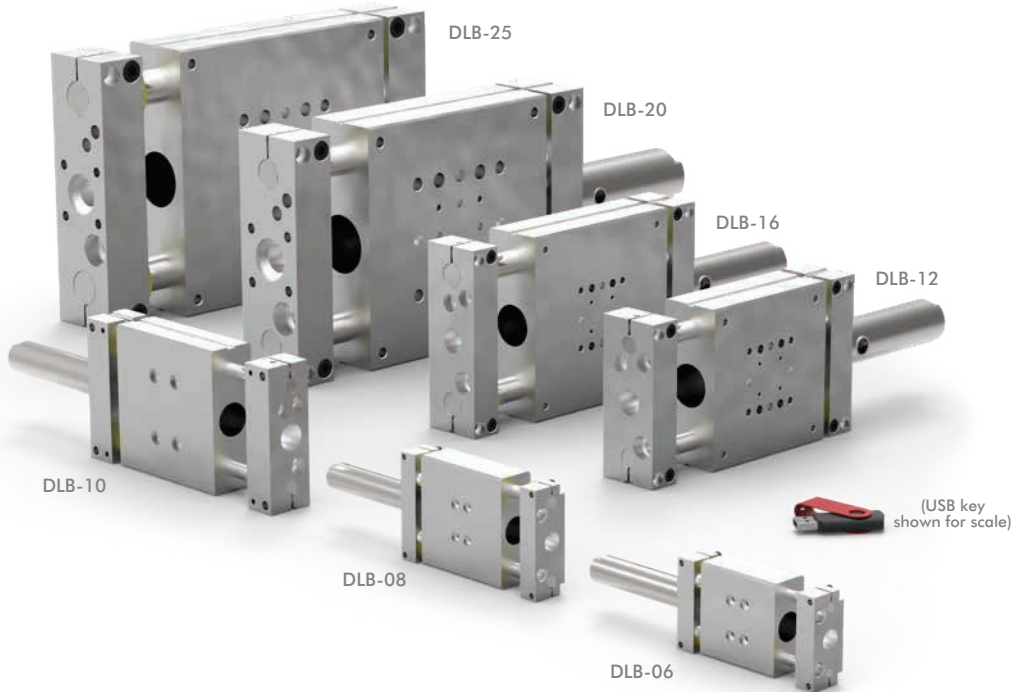

Size	Style	Stroke* Imperial (in)
DLB-06	T	.5, 1, 1.5, 2, 2.5, 3, 4, 5, 6
DLB-08	T	.5, 1, 1.5, 2, 2.5, 3, 4, 5, 6, 7, 8
DLB-10	T, A, N	1-12 @ 1" increments
DLB-12	T, A, N	1-16 @ 1" increments
DLB-16	T, A, N	1-20 @ 1" increments
DLB-20	T, A, N	1-24 @ 1" increments
DLB-25	T, A, N	1-26 @ 1" increments

Size	Style	Stroke* Metric (mm)
DLB-06M	T	10, 25, 40, 50, 75, 100, 125, 160
DLB-08M	T	10, 25, 40, 50, 75, 100, 125, 160, 175, 200
DLB-10M	A	25, 50, 80, 100, 125, 160, 200, 250, 300
DLB-12M	A	25, 50, 80, 100, 125, 160, 200, 250, 300, 320, 360, 400
DLB-16M	A	25, 50, 80, 100, 125, 160, 200, 250, 300, 320, 360, 400, 500
DLB-20M	N	25, 50, 80, 100, 125, 160, 200, 250, 300, 320, 360, 400, 500
DLB-25M	N	25, 50, 80, 100, 125, 160, 200, 250, 300, 320, 360, 400, 500

*Custom strokes available. Consult factory.

DLT SERIES - INTERNAL AIR CYLINDER

CLICK OR SCAN
To view full
catalog pages
on this product



Internal Air Cylinder Linear Thruster Slides

How To Order

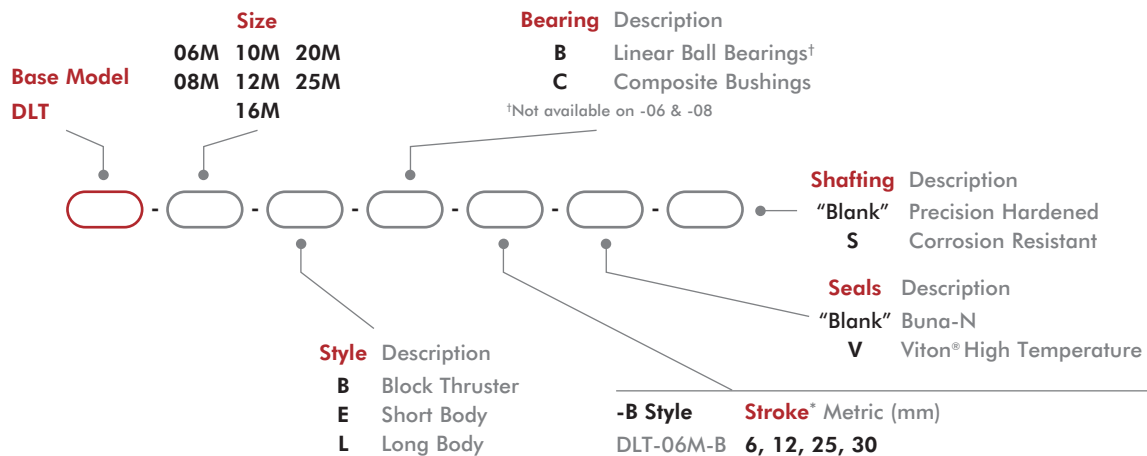
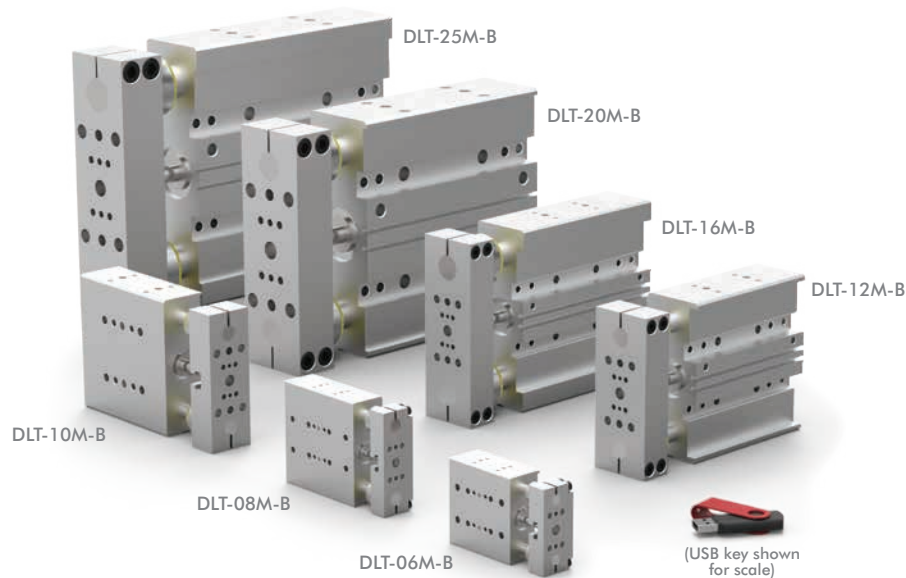

Size	Base Flange Kit (-B Only)	Cylinder Seal Kits	
		Buna-N	Viton®
06	ODLT-015	SLKT-108	SLKT-108V
08	ODLT-016	SLKT-100	SLKT-100V
10	ODLT-006	SLKT-102	SLKT-102V
12	ODLT-008	SLKT-104	SLKT-104V
16	ODLT-010		
20	ODLT-012		
25	ODLT-014		

-B Style	Stroke* Metric (mm)
DLT-06M-B	6, 12, 25, 30
DLT-08M-B	6, 12, 25, 30, 40, 44
DLT-10M-B	12, 25, 40, 50
DLT-12M-B	12, 25, 40, 50
DLT-16M-B	12, 25, 40, 50, 65, 75
DLT-20M-B	12, 25, 40, 50, 65, 75, 85, 100
DLT-25M-B	12, 25, 40, 50, 65, 75, 85, 100, 115, 125

-E Style	Stroke* Metric (mm)
DLT-06M-E	6, 12, 25, 30
DLT-08M-E	6, 12, 25, 40, 44
DLT-10M-E	25, 50
DLT-12M-E	25, 50
DLT-16M-E	25, 50, 75
DLT-20M-E	25, 50, 75, 100
DLT-25M-E	25, 50, 75, 100, 125

-L Style	Stroke* Metric (mm)
DLT-06M-L	12, 25, 40, 50, 65, 75
DLT-08M-L	12, 25, 40, 50, 65, 75, 85
DLT-10M-L	25, 50, 80, 100
DLT-12M-L	25, 50, 80, 100, 125
DLT-16M-L	25, 50, 80, 100, 125, 150
DLT-20M-L	25, 50, 75, 100, 125, 160
DLT-25M-L	25, 50, 75, 100, 125, 160, 175

*Custom strokes available. Consult factory.



CLICK OR SCAN
To view full
catalog pages
on this product

DLT SERIES - EXTERNAL AIR CYLINDER

External Air Cylinder Linear Thruster Slides

How To Order

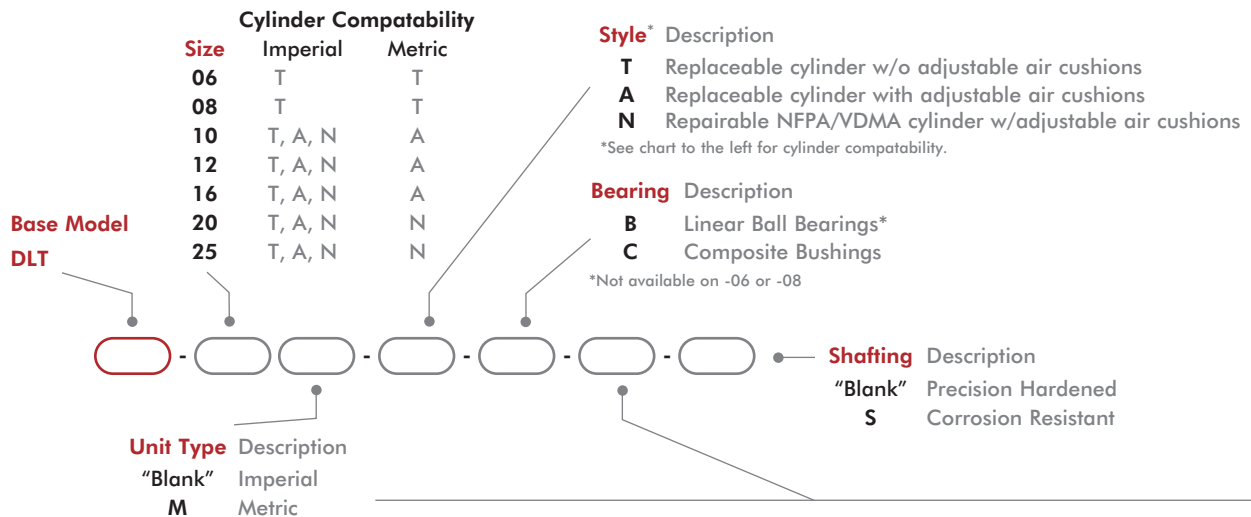
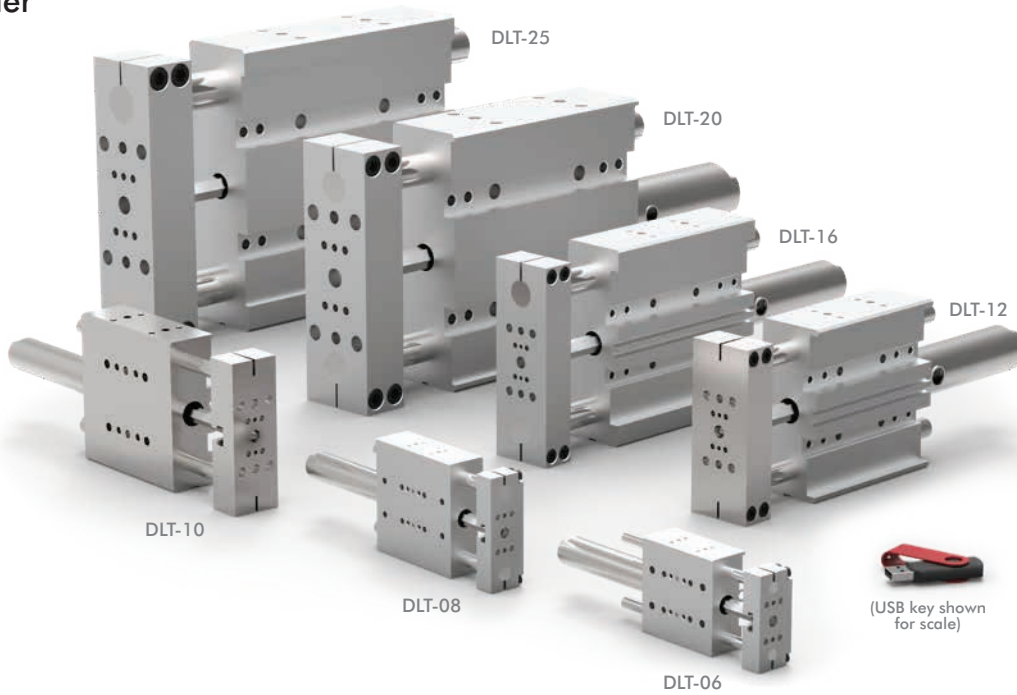

Size	Style	Stroke* Imperial (in)
DLT-06	T	.5, 1, 1.5, 2, 2.5, 3, 4, 5, 6
DLT-08	T	.5, 1, 1.5, 2, 2.5, 3, 4, 5, 6, 7, 8
DLT-10	T, A, N	1-12 @ 1" increments
DLT-12	T, A, N	1-16 @ 1" increments
DLT-16	T, A, N	1-20 @ 1" increments
DLT-20	T, A, N	1-24 @ 1" increments
DLT-25	T, A, N	1-26 @ 1" increments

Size	Style	Stroke* Metric (mm)
DLT-06M	T	10, 25, 40, 50, 75, 100, 125, 160
DLT-08M	T	10, 25, 40, 50, 75, 100, 125, 160, 175, 200
DLT-10M	A	25, 50, 80, 100, 125, 160, 200, 250, 300
DLT-12M	A	25, 50, 80, 100, 125, 160, 200, 250, 300, 320, 360, 400
DLT-16M	A	25, 50, 80, 100, 125, 160, 200, 250, 300, 320, 360, 400, 500
DLT-20M	N	25, 50, 80, 100, 125, 160, 200, 250, 300, 320, 360, 400, 500
DLT-25M	N	25, 50, 80, 100, 125, 160, 200, 250, 300, 320, 360, 400, 500

*Custom strokes available. Consult factory.

DLM SERIES

Miniature Rail Thruster Slide

How To Order

CLICK OR SCAN
To view full
catalog pages
on this product



Base Model DLM

Bearings Description
 "Blank" Single Bearings
D Double Bearings*
*Not available on DLM-07-12, 09-25, 12-25

Stops Description
 "Blank" None
P Precision Stops

Bore Size	Body Size	Stroke Metric (mm)
07M	12	5, 10, 12
	25	12, 15, 20, 25
	38	25, 30, 35, 38
	50	38, 40, 45, 50
09M or 12M	25	5, 10, 15, 20, 25
	50	25, 30, 35, 40, 45, 50
	75	50, 55, 60, 65, 70, 75
	100	75, 80, 85, 90, 95, 100

Size	Seal Repair Kits	
	Base Buna-N	Manifold Kit
07M	SLKT-236	SLKT-239
09M	SLKT-237	SLKT-240
09M	SLKT-238	

Basic Unit Dimensions

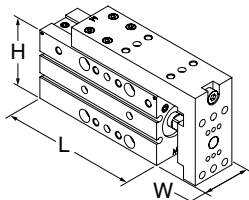

Size	L	W	H
07M-12	78 [3.07]	21 [0.83]	35.5 [1.40]
07M-25	102 [4.02]	21 [0.83]	35.5 [1.40]
07M-38	115 [4.53]	21 [0.83]	35.5 [1.40]
07M-50	127 [5.00]	21 [0.83]	35.5 [1.40]
09M-25	113 [4.45]	32 [1.26]	62 [2.44]
09M-50	159 [6.26]	32 [1.26]	62 [2.44]
09M-75	184 [7.24]	32 [1.26]	62 [2.44]
09M-100	209 [8.23]	32 [1.26]	62 [2.44]
12M-50	126 [4.96]	32 [1.26]	65 [2.56]
12M-75	166 [6.54]	32 [1.26]	65 [2.56]
12M-50	193 [7.60]	32 [1.26]	65 [2.56]
12M-100	218 [8.58]	32 [1.26]	65 [2.56]

MPS SERIES

Miniature Rail Thruster Slide

How To Order

CLICK OR SCAN
To view full
catalog pages
on this product

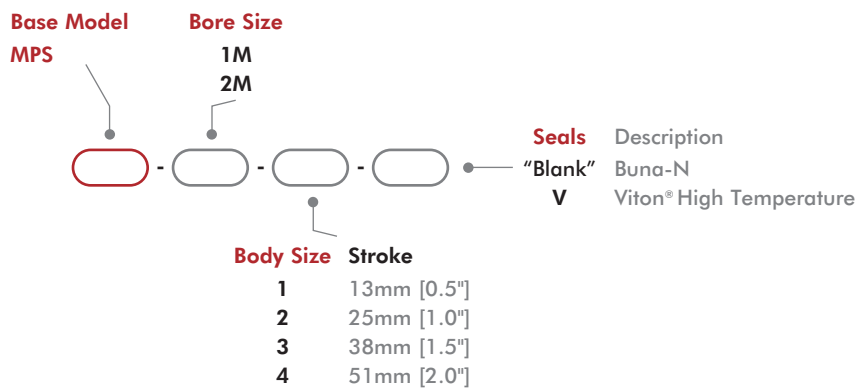
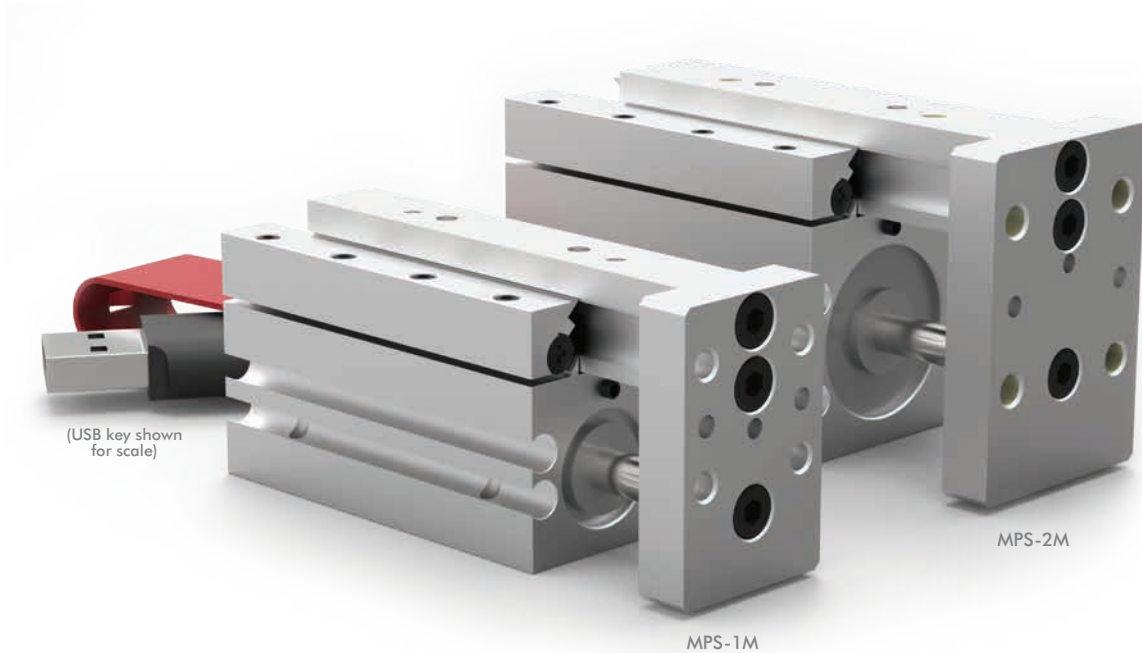

Basic Unit Dimensions

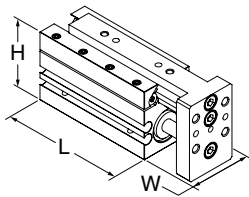

Size	L	W	H
1M-1	46 [1.81]	20.6 [0.81]	31.8 [1.25]
1M-2	63.4 [2.50]	20.6 [0.81]	31.8 [1.25]
1M-3	88.9 [3.50]	20.6 [0.81]	31.8 [1.25]
1M-4	113 [4.45]	20.6 [0.81]	31.8 [1.25]
2M-1	46 [1.81]	27 [1.06]	39.7 [1.56]
2M-2	64.4 [2.54]	27 [1.06]	39.7 [1.56]
2M-3	88.9 [3.50]	27 [1.06]	39.7 [1.56]
2M-4	113 [4.45]	27 [1.06]	39.7 [1.56]

RFE SERIES

Feed Escapements

How To Order

CLICK OR SCAN
To view full
catalog pages
on this product



See page 5-8 for product availability in your region.

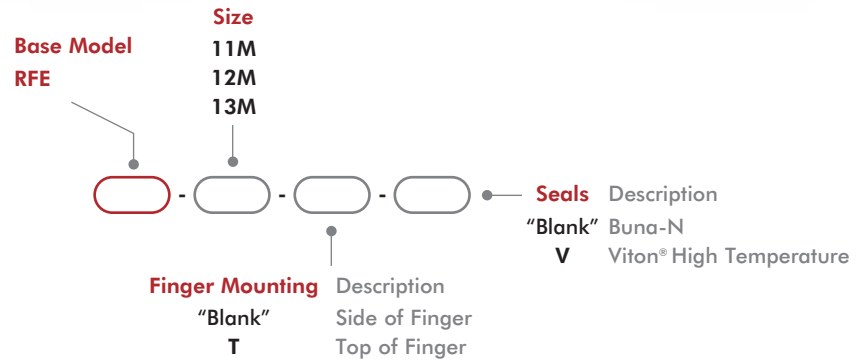
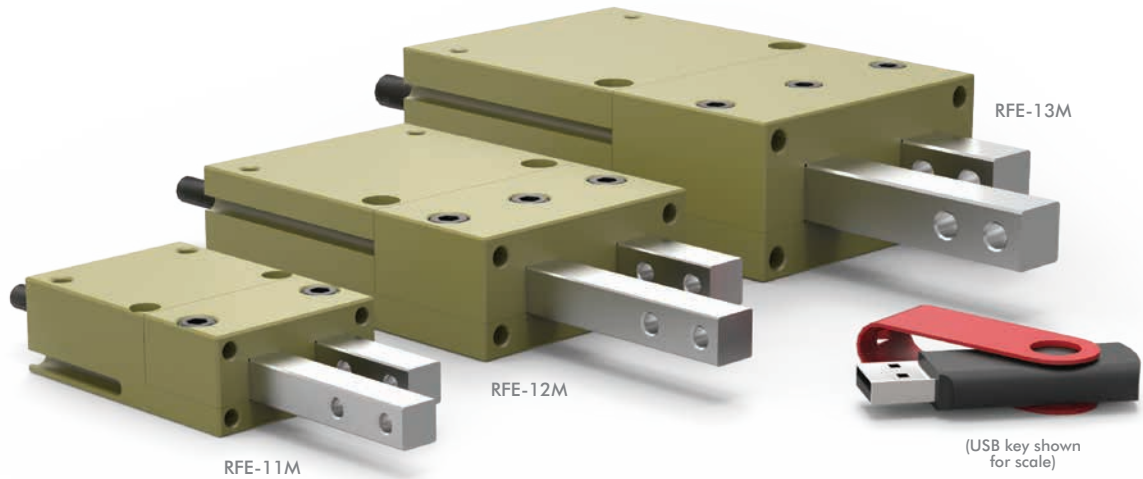

Size	Seal Repair Kits	
	Buna-N	Viton®
11M	SLKT-110	SLKT-110V
12M	SLKT-111	SLKT-111V
13M	SLKT-112	SLKT-112V

RN SERIES

Feed Escapements

How To Order

CLICK OR SCAN
To view full
catalog pages
on this product

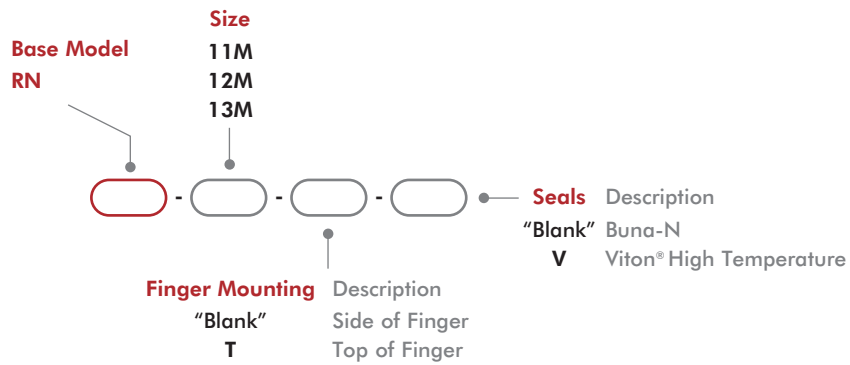
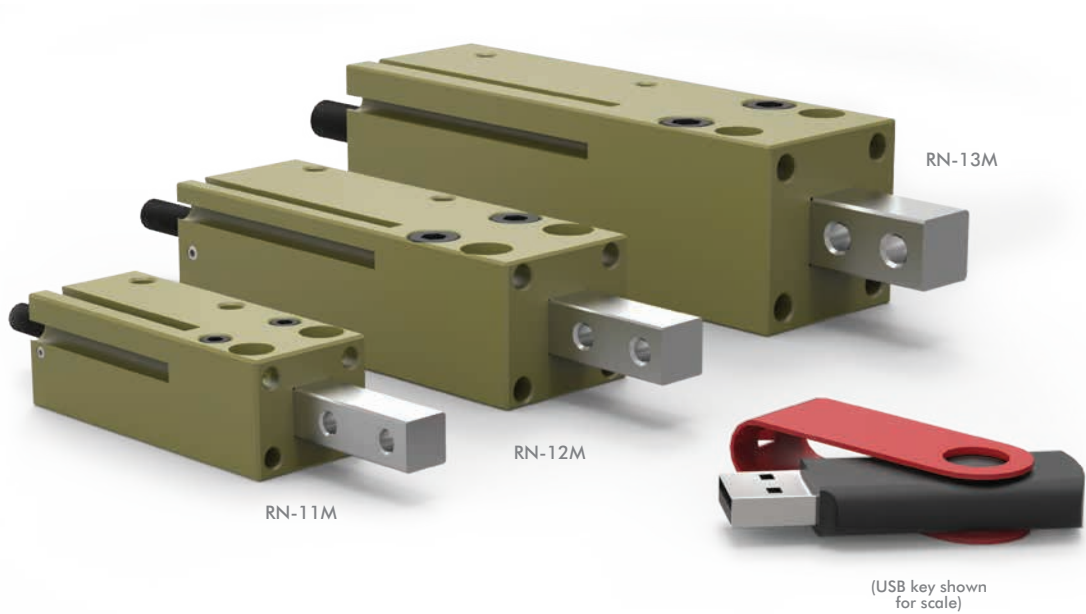

Size	Seal Repair Kits	
	Buna-N	Viton®
11M	SLKT-114	SLKT-114V
12M	SLKT-115	SLKT-115V
13M	SLKT-116	SLKT-116V